



PRODUCT CATALOG

2023 / 2024

STRAIN GAUGES

STRAIN GAUGE TRANSDUCERS

MEASURING INSTRUMENTS

AUTOMOTIVE MEASURING SYSTEM

Vehicle powertrain/Driving stability

SPECIAL PURPOSE MEASUREMENTS

MEASUREMENT SOFTWARE

Visual LOG®



Tokyo Measuring Instruments Laboratory Co., Ltd.

Strain Gauges with a Proven Performance Record



Advances in technology have led to construction of new structures that are more sophisticated and complex than any that have come before, such as buildings, vehicles, aircraft and industrial machines.

This trend has made strain measurement an even more critical part of ensuing structural integrity and safety.

We are industry leader in strain gauges. Our products enjoy an outstanding reputation both in Japan and abroad, where they meet the high-level needs of customers ranging from research facilities to civil engineering and construction companies.

We have also developed a wide variety of strain measurement accessory products to complement our strain gauges.

You can count on our field-proven products that meet the industry's highest standards for quality, accuracy and performance.

We are
accredited in
FORCE field.



Tokyo Sokki Kenkyujo Co., Ltd. (TML) is accredited by Japan Calibration Service System (JCSS), conformed to international standards JIS Q 17025 (ISO/IEC 17025) under the laboratory accreditation body ISO/IEC 17011. International Accreditation Japan (IA Japan) plays as the accreditation body of JCSS and is a signatory to MRA of Asia Pacific Accreditation Cooperation (APAC) as well as International Laboratory Accreditation Cooperation (ILAC). Our Kiryu factory is certified as a JCSS-accredited laboratory working in compliance with an international Mutual Recognition Arrangement (MRA). The accreditation number of the Kiryu Factory is 0090.

Calibration Service

Offers calibration service and support for your measuring instruments

Maintaining strict calibration for various measuring instruments to be used is essential. We offer calibration service to certify that the instruments are traceable to National standards.

We perform highly reliable calibration in accordance with our calibration service standards using instruments and methods for calibration that are traceable to national standards.

Certificates including "Certificate of Calibration" and "Certificate of Traceability" will be issued for calibrated instruments at your request. (Optional)

- Issue of certificate of calibration with logo of MRA (mutual recognition arrangement)/JCSS for force transducers
For a load cell, JCSS calibration or general calibration according to our in-house standards is available. The JCSS calibration is applicable only for a force transducer (combination of a load cell and a measuring instrument).
- Our force calibration machine that is calibrated directly by National Institute of Advanced Industrial Science and Technology (AIST) (up to 10MN)
- Combined calibration with other maker's product
Certificate of calibration or certificate of traceability for combined devices
N.B. Calibration for other maker's product only is not acceptable.
- Measurement management in accordance with ISO9001
- EMC (electromagnetic compatibility) calibration for our instruments
Issue of the following certificates is available for the calibrated devices at your request.
- [Certificate of JCSS Calibration / Certificate of Calibration] or [Short-form Certificate of Calibration] to certify calibration and traceability for individual product
The Certificate of JCSS Calibration will be issued only for a force transducer (combination of a load cell and a measuring instrument).
- [Detailed Certificate of Calibration] including calibration data for all devices used for the calibration
- [Certificate of Traceability] showing that the devices used for the calibration are traceable to National Standards or public calibration laboratories
- [Certificate of Combined Calibration] for combination with our product or other maker's product

Calibration Certificate

JCSS Calibration Certificate for combined Load Cell and instrument







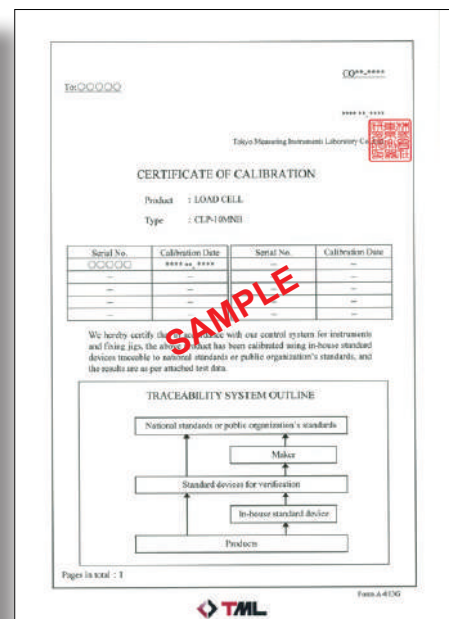

General Certificate of Calibration



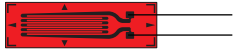
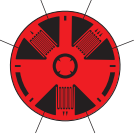

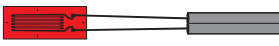
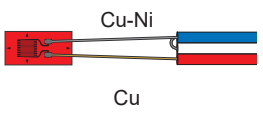

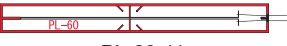
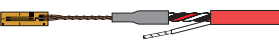
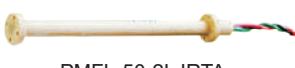

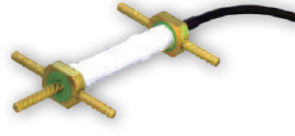

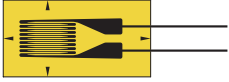
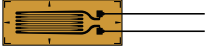

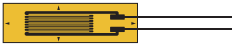

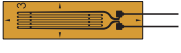
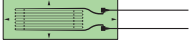

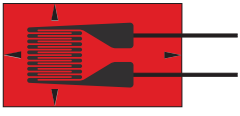

Short-form Certificate of Calibration







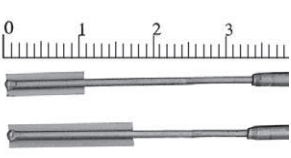

The calibration period of product should be appropriately defined by the user considering the form and purpose of use, our recommendation for calibration period, maintenance management costs, and so on. Our recommendation for calibration period is one year in ordinary usage.

Gauge Series	Gauge Pattern (example)	Description	Gauge Length (mm)	Operating Temperature Range (°C)	Remarks
Foil Strain Gauge GOBLET CE	 FLAB-5-11	GOBLET gauges are based on our standard F-series gauges, and they are compliant with RoHS2 Directive 2011/65/EU. These gauges are supplied with CE marking.	0.2~30	-196~+150	Single/2- /3- element
Foil Strain Gauge F CE	 FRS-3-11-F For residual stress measurement	This gauge employs special plastics for the backing which exhibits excellent electrical insulation performance and extended operating temperature range. A variety of strain gauges with gauge lengths of 0.2mm to 30mm are available. Also available are 3-element rosette gauges for principal stress analysis, and special purpose gauges including 5 or 10- element paralleled gauges for stress concentration measurement.	0.2~30	-196~+150	Single/2- /3- element Special
Integral leadwire Strain Gauge CE	 FLAB-6-11-3LJCT-F  FLAB-6-11-1LJC-F	These are F, PF or P series strain gauges with extension leadwires pre-attached. They greatly save the time and labor for leadwire connection works during the strain gauge installation. They are available with 2-wire (1, 3 or 5 meter) or 3-wire (3 or 5 meter) paralleled vinyl leadwire. In addition, various leadwires to meet usage conditions, and leadwire for 1-gauge 4-wire connection with modular plug are also available.	—	—	Single/2- /3- element
Temperature-integrated Strain Gauge	 Cu-Ni Cu FLAB-2T-11-3TLJBT-F	This is our original strain gauge with thermocouple. Most of our foil strain gauges including F-series are available in this configuration. A T-thermocouple is composed of Cu-Ni wire and Cu wires used for the leadwire. Strain measurement with quarter bridge 3-wire method and accurate temperature measurement are possible using our data logger.	1~5	FLAB-T: -20~+80 QFLAB-T: -20~+200	Single element
Polyester Foil Strain Gauge PF	 PFL-10-11	This is a strain gauge having a polyester resin backing which is the same as that of the P-series gauge and a sensing part made of foil. The backing is transparent and the installation is easy. It is applicable to mortar, concrete and metal.	10~30	-20~+80	Single/2- /3- element
Polyester Strain Gauge P CE	 PL-60-11	This is a wire strain gauge utilizing a polyester resin backing. It is mainly used for measurement on concrete. Since the backing is transparent, the bonding position can easily be checked. Installation is easy even in field measurement.	60~120	-20~+80	Single/2- /3- element
Magnetic Field Strain Gauge QMF CE	 QMFLA-2-□-005LET -6FD○LTSS-F	This gauge is designed for strain measurement in the magnetic field. The gauge uses a material which exhibits low magnetoresistance for the sensing element. It is also configured to reduce the effect of electromagnetic induction.	2, 5	-30~+200	Single/2- /3- element
Mold Strain Gauge PMF CE	 PMFL-50-2LJRTA	This gauge is embedded in concrete or mortar for measurement of internal strain. It is suited for short-term measurement such as a loading test.	50, 60	-20~+60	Single element
Asphalt Mold Strain Gauge PMFLS	 PMFLS-60-50-2LTS	This gauge is designed for measurement of internal strain of asphalt. The material of the backing is super engineering plastics featuring high temperature resistivity and waterproofing performance. It can withstand a high temperature up to 200°C during placement of asphalt.	60	-20~+60	Single element
Concrete surface and/or embedment Strain Transducer KM CE		The KM series strain transducers are designed to measure strain in materials such as concrete, synthetic resin which undergo a transition from a compliant state to a hardened state. A built-in thermocouple sensor models enable actual temperature measurement in addition to strain measurement. Adding to the above embedment use, surface strain measurement on concrete or H-beam steel is also available.	50~200	-20~+180	Strain : Full bridge Temperature : Quarter bridge 3-wire
Asphalt embedment Strain Transducer KM-100HAS CE		This strain transducer consists of flanges at which reinforcing bars are mounted for a good fixation in asphalt pavement materials, a thin spring element connected to the flanges, and metallic pipe and fluoroplastic tape to protect the spring element. This transducer has a heat-resistive and waterproof construction. The asphalt strains are converted into electrical signals and can be read out with a strainmeter.	100	-20~+180	Strain : Full bridge Temperature : Quarter bridge 3-wire

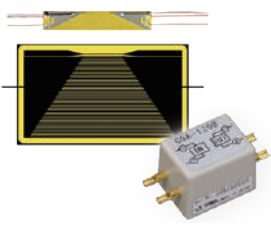
Gauge Series	Gauge Pattern (example)	Description	Gauge Length (mm)	Operating Temperature Range (°C)	Remarks
Post-Yield Strain Gauge YF CE	 YFLA-5	This gauge is designed for measurement of large strain which cannot be measured using ordinary strain gauges because peeling-off or disconnection may occur in the ordinary strain gauge. It is also applicable to measurement of repeated strain in elastic range. Strain limit: The YF series is for 15 ~ 20%	2, 5	-20~+80	Single/2- /3- element
Single element Strain Gauge YEF GOBLET CE	 YEFLAB-5	This gauge is designed for measurement of large strain which cannot be measured using ordinary strain gauges because peeling-off or disconnection may occur in the ordinary strain gauge. It is also applicable to measurement of repeated strain in elastic range. Strain limit: The YEF series is for 10 ~ 15%	2, 5	-30~+80	Single/2- /3- element
Post-Yield Strain Gauge YHF CE	 YHFLA-5	This gauge is designed for measurement of large strain. It features very large strain limit of 30 ~ 40% in room temperature. It is not applicable to measurement of repeated strain either in elastic or in large strain range.	2, 5	-30~+80	Single element
High Endurance Strain Gauge DSF	 DSFLA-5-350	This gauge is designed for measurement in fatigue test of materials. It satisfies fatigue life over 10 million times at strain level of $\pm 3000\mu\epsilon$.	2, 5	-20~+200	Single element
For measuring coefficient of linear thermal expansion Strain Gauge CTE	NEW  CTELA-6	This strain gauge is a product in which the temperature compensated material of the strain gauge is adjusted to $0 \times 10^{-6}/^{\circ}\text{C}$ so that the coefficient of linear thermal expansion any material can be easily calculated. Patent pending (JP-A2023-179142)	3, 6	-30~+200	Single element
Composite Strain Gauge UBF CE	 UBFLA-03	This gauge is developed for measurement on composite materials. It has a specially designed grid pattern to reduce the stiffening effect to the specimen. In addition, owing to the use of highly compliant gauge backing, characteristics in thermal cycle test and gauge creep have been significantly improved.	0.3, 1	Static -30~+120 Dynamic -30~+150	Single element
Composite Strain Gauge BF GOBLET CE	 BFLAB-5-3	This is a foil strain gauge designed for measurement on composite materials. It has a specially designed grid pattern to enable small stiffening effect to the specimen. Two or three axis gauge is also available. GOBLET gauge is compliant with RoHS2 Directive 2011/65/EU. It is supplied with CE marking.	2, 5	-30~+200	Single/2- /3- element
Low elastic Strain Gauge GF GOBLET CE	 GFLAB-6-350-50	This gauge is suited to measurement on materials such as plastics, which have low elastic modulus compared to metal. The specially designed grid reduces the stiffening effect of strain gauge to the specimen. Self temperature compensation of 50 or $70 \times 10^{-6}/^{\circ}\text{C}$ is available. GOBLET gauge is compliant with RoHS2 Directive 2011/65/EU. It is supplied with CE marking.	3, 6	-30~+80	Single/2- /3- element
Strain Gauge for wood and gypsum LF GOBLET CE	 LFLAB-10-11	This gauge is for measurement on materials having low elastic modulus such as wood or gypsum. The use of specially designed plastics backing and grid configuration reduces the stiffening effect of strain gauge to the specimen. GOBLET gauge is compliant with RoHS2 Directive 2011/65/EU. It is supplied with CE marking.	10	-30~+80	Single element
Cryogenic temperature Strain Gauge CF CE	 CFLA-1-350-11	This is a foil strain gauge with epoxy backing. The sensing foil is made of special alloy. Stable measurement is possible owing to its excellent performance from cryogenic to room temperature range.	1, 3, 6	-269~+ 80	Single/2- /3- element

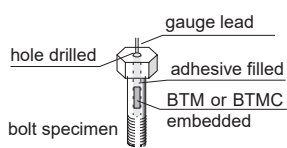
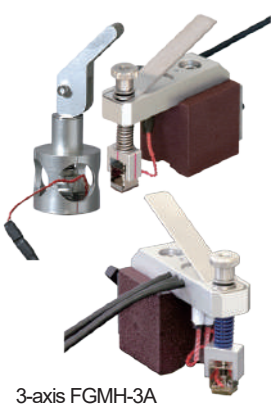
Gauge Series	Gauge Pattern (example)	Description	Gauge Length (mm)	Operating Temperature Range (°C)	Remarks
High temperature Strain Gauge QF GOBLET CE	 QFLAB-5-11  QFRAB-1	This is a foil strain gauge having polyimide backing which exhibits excellent performance in high temperature. For 2- and 3- element gauges, stacked configuration has been introduced to make the backing size smaller. GOBLET gauge is compliant with RoHS2 Directive 2011/65/EU. It is supplied with CE marking.	0.2~30	-20~+200	Single/2- /3- element
High temperature Strain Gauge QF CE	 QFLT-1B  QFYV-1	This is a foil strain gauge having polyimide backing which exhibits excellent performance in high temperature. Strain gauges for special measurement purpose such as stress concentration or shearing strain are also available in this series.	0.2~6	-20~+200	Single / 2- element Special
High temperature Strain Gauge ZF CE	 ZFLA-1-11	This strain gauge utilizes polyimide resin for the backing and Ni-Cr alloy foil of special pattern for the grid. Owing to these design, it is capable of measurement up to 300°C.	1~6	-20~+300	Single/2- /3- element
High temperature Strain Gauge EF CE	 EFLK-02-11  EFRA-05	This is a polyimide backing strain gauge for high temperature use. It is designed very small to meet to the measurement of print circuit boards or surface mounted devices which are getting smaller. The maximum operating temperature is 300°C for single-element gauges, which is different from that for 2- and 3-element gauges.	Single 0.2 2- 3- element 0.5	Single: -196~+300 2- / 3- element: -196~+200	Single/2- /3- element
Weldable Strain Gauge AW-6 CE	 AW-6-350-11-01LT	This gauge is made of a 0.08mm thick stainless steel backing and a high temperature strain gauge mounted on it with heat curing adhesive. Strain measurement is possible by merely installing the backing on a specimen using the spot welder (W-50RC). It is especially suited to measurement in high temperature up to 300°C, on a specimen difficult to bond strain gauges, or for a long term.	6	-196~+300	Single/2- /3- element
Weldable Strain Gauge AWC CE	 AWC-8B-11-3LTSB	This gauge has hermetically sealed construction with the strain sensing element encapsulated in a stainless steel tube. Strain measurement is possible by merely installing the backing on a specimen using the spot welder (W-50RC). It can simplify the coating for moisture/water proofing, and is suited to measurement in harsh environment and/or for a long term.	8	-20~+100	Single element
Weldable Strain Gauge AWM/AWMD AWH CE	 AWH	This gauge has a backing made of metal such as stainless steel. It is mounted by installing the backing on a specimen using the spot welder (W-50RC). It is suited to measurement for a long term, in harsh environment and/or in high temperature.	AWM-8 8 AWMD-5/-8 5, 8 AWH-4/-8 4, 8 AWH-4/-8 4, 8	196~+300 -196~+800 -196~+600 -196~+650	Static/dynamic measurement Dynamic measurement Static measurement Dynamic measurement

Gauge Series	Gauge Pattern (example)	Description	Gauge Length (mm)	Operating Temperature Range (°C)	Remarks								
1-gauge 4-wire strain measuring method		This is our unique technique, in which strain is measured by connecting the strain gauge resistance in series with the reference resistance. The use of four lead wires eliminates errors caused by the lead wire resistance and contact resistance. The modular plug enables easy connection and efficient wiring works. Extension of lead wire and/or number of measuring points are also easy. Correction by calculation is not necessary.			Please contact us for the details.								
	Single-axis 1-gauge 4-wire strain gauge  Modular plug  0°/45°/90° 3-axis rosette 1-gauge 4-wire strain gauge												
Crack Gauge FAC CE		This gauge is designed to measure the progress of crack on a metal surface caused by fatigue. The crack gauge is bonded on a position where the crack is initiated or the initiation is estimated, and it is measured using the crack gauge adaptor (CGA-120B) together.	—	-30~+80	Single element								
Bolt Strain Gauge BTM/BTMC CE	BTM  BTMC   gauge lead hole drilled adhesive filled BTM or BTMC embedded bolt specimen	This gauge is intended for measurement of tensile strain of bolt. A hole is pre-drilled in the center of the bolt and the bolt gauge is embedded in the hole with A-2 adhesive (for BTM) or CN adhesive (for BTMC). This method is effective to prevent the strain gauge being damaged while the bolt is inserted and tightened.	BTM: 1, 6 BTMC: 0.5, 1, 3	-10~+80	Single element								
Strain Checker FGMH CE	Single axis FGMH-1B FGMH-2A  3-axis FGMH-3A	While an ordinary strain gauge measures strain through an adhesive layer, the strain checker picks up strain through friction generated on the contact surface by pressing down the sensing part to the specimen with magnet force. It is easily fixed on the position of interest and immediately gets ready for measurement. It is also suited to changing the measurement position or to measuring repeatedly. The frictional strain gauge is a consumable part. If it is stained, deteriorated or damaged, replace it with a new one. Option : Applicable frictional strain gauge <table border="1" data-bbox="614 1568 1037 1724"> <thead> <tr> <th>Type</th> <th>Applicable frictional strain gauge (CE compliant)</th> </tr> </thead> <tbody> <tr> <td>FGMH-1B</td> <td>CBF-6B-01LJAP-F</td> </tr> <tr> <td>FGMH-2A</td> <td>CBF-3B-004LJAP-F</td> </tr> <tr> <td>FGMH-3A</td> <td>CBFR-3B-006LJAP-F</td> </tr> </tbody> </table>	Type	Applicable frictional strain gauge (CE compliant)	FGMH-1B	CBF-6B-01LJAP-F	FGMH-2A	CBF-3B-004LJAP-F	FGMH-3A	CBFR-3B-006LJAP-F	—	0~+60	Single element 3-element
Type	Applicable frictional strain gauge (CE compliant)												
FGMH-1B	CBF-6B-01LJAP-F												
FGMH-2A	CBF-3B-004LJAP-F												
FGMH-3A	CBFR-3B-006LJAP-F												
Spot Welder W-50RC CE		This is a spot welder used for installing weldable strain gauges and installing lead wires. The welding energy is selected between two ranges of 1~ 10 and 5~ 50 watt second. Since the output pulse width is as short as 5 ms, thermal damage applied to the welded material is extremely small. The stabilizing circuit of the welder cancels the effect of change in the power source voltage. The electrical cables are stored in the enclosure when carrying or storing for convenient handling.											

STRAIN GAUGE ADHESIVES

Type	Component	Operating temperature (°C)	Applicable specimen	Remarks
P-2*	Polyester	-30 ~ +180	Metal	Two-component (mixing ratio 1~3%), Room-temperature-curing, For general purpose
RP-2*	Polyester	-30 ~ +180	Concrete, Mortar	Two-component (mixing ratio 2~4%), Room-temperature-curing
NP-50B*	Polyester	-30 ~ +300	Metal, Composite	Two-component (mixing ratio 2~3%), Room-temperature-curing, For high temperature
PS*	Polyester	-30 ~ +100	Concrete, Mortar, Wood	Two-component (mixing ratio 2~4%), Room-temperature-curing
CN	Cyanoacrylate	-196 ~ +120	Metal, Plastics, Composite	Fast-curing, Single component, For general purpose
CN-E	Cyanoacrylate	-30 ~ +120	Porous material, Concrete, Mortar, Wood	Fast-curing, Single component, More viscous than CN
CN-Y	Cyanoacrylate	-30 ~ +80	Metal, Plastics, Composite	Fast-curing, Single component, For post-yield strain gauge (large strain)
CN-R	Cyanoacrylate	-30 ~ +120	Metal, Plastics, Composite	Fast-curing, Single component, Extremely quick curing exclusively for winter
C-1*	Phenol	-269 ~ +200	Metal	Single component, Heat-curing, For long-term measurement and transducers
EA-2A*	Epoxy	-269 ~ +50	Metal, Concrete, Composite	Two-component (mixing ratio 2:1), Room-temperature-curing, For cryogenic use
EB-2*	Epoxy	-60 ~ +200	Metal, Composite	Two-component (mixing ratio 10:3), Room-temperature-curing, For long-term measurement
A-2*	Epoxy	-30 ~ +100	Installation of Bolt strain gauge	Two-component (mixing ratio 10:1), Heat-curing

SDS (Safety data sheet)

SDS is available for every adhesive. Read the SDS before use. Contact us or your local supplier for more information.

*Dangerous Goods in Exceeded Quantities



COATING MATERIALS for Strain Gauges

Example of single layer coating

Example of multi-layer coating

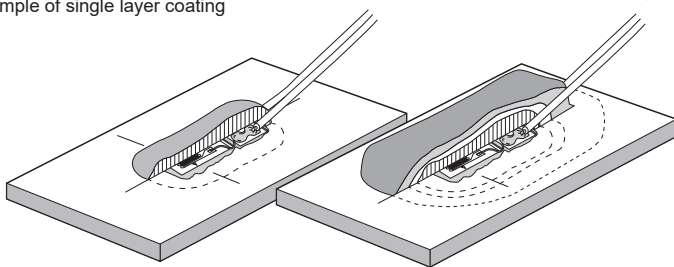

Type	Character	Operating temperature (°C)	Curing conditions	Materials	Description
W-1	Hot-melt type	0 ~ +50	Hot-melting at 100~120°C Room temperature curing	Microcrystalline wax	For general purpose. Melted by heating and applied with brush. Suitable for single layer coating and prime coating for multi-layer coating.
N-1*	Rubber based Solvent thinned	-30 ~ +80	Air-drying A half day at room temperature	Chloroprene rubber based	Applied with brush and completed with drying. Suitable for single layer coating.
K-1*	Rubber based Solvent thinned	-269 ~ +60	Air-drying A half day at room temperature	Special rubber	Exhibits small stiffening effect at cryogenic temperature.
UE-1*	Rubber based Solvent thinned	-40 ~ +150	Air-drying A half day at room temperature	Special rubber	Exhibits excellent oil-proof performance.
SB Tape	Rubber based tape	-30 ~ +80	Pressure bonding	Butyl rubber based	Tape-shaped and easy to apply. Suitable for various uses including prime coating of strain gauges and sealing around lead wires.
VM Tape	Rubber based tape	-20 ~ +80	Pressure bonding	Butyl rubber based	Tape-shaped and easy to apply.

SDS (Safety data sheet)

SDS is available for every coating material. Read the SDS before use. Contact us or your local supplier for more information.

*Dangerous Goods in Exceeded Quantities

CONNECTING TERMINALS

Connecting terminals provide convenient junction points to connect strain gauges to instrumentation lead wires.

Cubic shape terminal

For general purpose

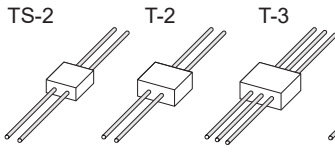

For large strain (with rubber backing)

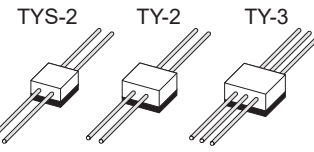

Self-bonding type (No adhesive required)

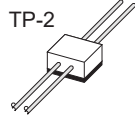

Foil shape terminal

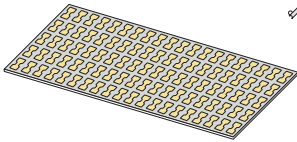

For general purpose



For large strain (with rubber backing)



TF-2SS TF-2S TF-2MS TF-2M TFY-2SS TFY-2S TFY-2MS TFY-2M

High temperature use (with polyimide resin backing)



TPF-2SS TPF-2S TPF-2MS TPF-2M

TPFH-2SS TPFH-2S TPFH-2MS -

NB: The TPFH series are connecting terminals having polyimide resin backing with heat resistivity superior to that of TPF series. It is recommended for use with high temperature strain gauge QF/ZF series, or for the case where repetition of connection and removal of lead wires are expected on the connecting terminal.

Cubic shape terminal

Type	Depth×Width×Height (mm)	Operating temperature(°C)	Quantity (pcs./package)
TS-2	7.5×7.5×5	-20~+90	100
T-2	10×10×5	-20~+90	100
T-3 (for 3-wire method)	10×10×5	-20~+90	100
TYS-2	7.5×7.5×7	-20~+90	100
TY-2	10×10×7	-20~+90	80
TY-3 (for 3-wire method)	10×10×7	-20~+90	80
TP-2	10×10×6	-20~+60	100

Foil shape terminal

Type	Depth × Width×Thickness (mm)	Operating temperature (°C)	Quantity (pairs/sheet)
TF-2SS	4.6×3.8×0.2	-196~+180	50
TF-2S	6×5.3×0.2	-196~+180	50
TF-2MS	8×7.2×0.2	-196~+180	50
TF-2M	10×9.2×0.2	-196~+180	50
TFY-2SS	4.6×3.8×0.8	-20~+120	50
TFY-2S	6×5.3×0.8	-20~+120	50
TFY-2MS	8×7.2×0.8	-20~+120	50
TFY-2M	10×9.2×0.8	-20~+120	50
TPF-2SS	4.6×3.8×0.2	-196~+200	50
TPF-2S	6×5.3×0.2	-196~+200	50
TPF-2MS	8×7.2×0.2	-196~+200	50
TPF-2M	10×9.2×0.2	-196~+200	50
TPFH-2SS	4.6×3.8×0.1	-269~+350	50
TPFH-2S	6×5.3×0.1	-269~+350	50
TPFH-2MS	8×7.2×0.1	-269~+350	50

STRAIN GAUGE CLAMP

Gauge Mate GMR-S **REACH**

When bonding a strain gauge, a fixing pressure should be applied to the gauge until the adhesive cures completely. This can be easily done by using Gauge Mate, which is a clamping device consisting of a coil spring and a permanent magnet. It is suitable to use for room-temperature-curing adhesive.

Type	Application
GMR-S	for Round bar (Φ6 ~ 32 mm)

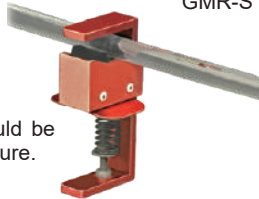

NB: The Gauge Mate should be used only at room temperature.

PRESSEE PM-19 **REACH**

PRESSEE is a jig capable of not only pressurizing (PRESS) the strain gauge but also checking the pressing status with eyes (SEE). The use of PRESSEE saves time to keep pressing the strain gauge with your finger and helps to improve the work efficiency.

Applicable strain gauge	Gauge length of 6mm or less (Backing dimension of Φ15mm or less)
Applicable adhesive	CN/CN-R/CN-Y, P-2, NP-50B EA-2A, EB-2
Pressing method	Magnetic force by permanent magnet
Object to be bonded	Flat surface of magnetic body (Steel plate with thickness of 1mm or more)
Dimensions	Φ29mm × approx. 30mm height



Strain Gauge User's Guide / Strain Gauge Performance Characteristics



TML strain gauges are available in many types according to the measurement conditions. Since strain gauges function only when they are mounted on the target material, they must be selected correctly based on the material, operating temperature, measurement environment, and mounting dimensions of the object to be measured. This "Strain Gauge User's Guide" is intended for beginners, and is compiled based on our actual strain gauge installation work to summarize the essentials of strain gauge handling.

This book is a compilation of strain gauge handling essentials based on actual strain gauge installation work at TML.











Although strain gauges have many conveniences and are already used in various fields, it is also true that there are limits to their use. It is necessary to use strain gauges after determining the usage limits in advance, depending on the material and shape of the material to be measured, temperature, strain amount, speed, fatigue, environment, etc. The "TML Strain Gauge Characteristics Guide" introduces various characteristics of TML strain gauges based on currently available materials, information, and data.



It should be used in conjunction with the TML Strain Gauge User's Guide.





Load Cells			
<p>CLS-NA/CLS-NB</p>  <p>CE (only for CLS-NB)</p> <p>Compression, Miniature 2N ~ 10kN</p>	<p>CLA-NA</p>  <p>CE</p> <p>Compression 500N ~ 20kN</p>	<p>CLG-NB</p>  <p>CE</p> <p>Compression, Low profile 10 ~ 200kN</p>	<p>CLP-NB</p>  <p>CE</p> <p>Compression 10kN ~ 10MN Dual-output type with two isolated I/O ports is available as an option</p>
<p>CLU-NA</p>  <p>CE</p> <p>Compression 10kN ~ 1MN Dual-output type with two isolated I/O ports is available as an option</p>	<p>CLM-NB</p>  <p>CE</p> <p>Compression, High performance 10~ 500kN</p>	<p>CLJ-NA</p>  <p>CE (made-to-order)</p> <p>Compression, High performance 5 ~ 30kN Remote sensing applicable</p>	<p>CLJ-NB</p>  <p>CE</p> <p>Compression, High performance 50kN ~ 10MN Remote sensing applicable</p>
<p>CLF-NA</p>  <p>CE</p> <p>Compression, Low profile 500kN ~ 2MN</p>	<p>CLL-NA/CLH-NA</p>  <p>CE</p> <p>Compression, Flat loading surface CLH-NA: 1 ~ 2MN CLL-NA: 500kN ~ 1MN</p>	<p>CLR-NAH</p>  <p>CE</p> <p>Compression, For high temperature use 500N ~ 200kN Allowable temperature: -10 ~ +160°C</p>	<p>KCE-NA</p>  <p>CE</p> <p>Compression, Center-hole 500kN ~ 2MN</p>
<p>KCM-NA</p>  <p>CE</p> <p>Compression, Center-hole 10kN ~ 5MN</p>	<p>KCH-NA</p>  <p>CE</p> <p>Center-hole 500kN~2MN</p>	<p>CLC-NA</p>  <p>CE</p> <p>Compression, Center-hole 50kN ~ 5MN</p>	<p>KCG-NA</p>  <p>CE</p> <p>Compression, Center-hole Strand force measurement 200kN</p>
<p>KCC-NA</p>  <p>CE (made-to-order)</p> <p>Compression, Center-hole 200kN ~ 1MN</p>	<p>KCK-NA</p>  <p>CE</p> <p>Compression, Center-hole 500kN/1MN</p>	<p>TCLB-NA</p>  <p>CE (made-to-order)</p> <p>Tension/Compression 50 ~ 200N</p>	<p>TCLA-NB</p>  <p>CE</p> <p>Tension/Compression 500N ~ 20kN</p>
<p>TCLK-NA</p>  <p>CE</p> <p>Tension/Compression 5 ~ 50kN</p>	<p>TCLZ-NA / TCLZ-NB</p>  <p>CE (only for TCLZ-NA)</p> <p>TCLZ-NA TCLZ-NB</p> <p>Tension/Compression High performance 10N ~ 10kN (TCLZ-NB:10N-200N)</p>	<p>TCLM-NB</p>  <p>CE</p> <p>Tension/Compression High performance 10 ~ 200kN</p>	<p>TCLY-NA</p>  <p>CE</p> <p>Tension/Compression High performance 300kN ~ 10MN</p>

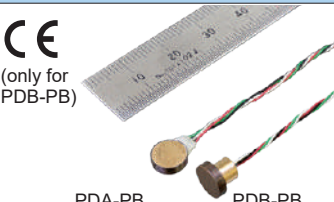
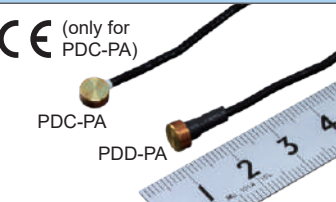



Load Cells			
<p>TCLP-NB</p>  <p>Tension/Compression 10kN ~ 2MN Dual-output type with two isolated I/O ports is available as an option</p>	<p>TCLU-NA</p>  <p>Tension/Compression 10 ~ 200kN Dual-output type with two isolated I/O ports is available as an option</p>	<p>TCLN-NA</p>  <p>Tension/Compression, Small 500N ~ 5kN</p>	<p>TLJ-NA (made-to-order)</p>  <p>Tension, High performance 10 ~ 100kN Remote sensing applicable</p>
3-component Load Cell		Torque Transducer	
<p>TLP-NB</p>  <p>Tension 10kN ~ 1MN Dual-output type with two isolated I/O ports is available as an option</p>	<p>SLP-NA-T (made-to-order)</p>  <p>Low capacity 3-component load cell 100N ~ 1kN</p>	<p>LTA-NA</p>  <p>Socket wrench torque transducer 50N·m ~ 500N·m</p>	<p>LTB-NA</p>  <p>Flange type torque transducer 10N·m ~ 1kN·m</p>
Displacement Transducer			
<p>CDP/CDP-D</p>  <p>High sensitivity CDP: 5 ~ 100mm CDP-D: 50/100mm (dual-output: option)</p>	<p>CDP-M/CDP-MT</p>  <p>High sensitivity, Small 5 ~ 100mm</p>	<p>CDP-T</p>  <p>Tension, High sensitivity 25mm</p>	<p>DDP-A</p>  <p>Dial gauge type 10 ~ 50mm</p>
<p>SDP-E</p>  <p>General purpose 50 ~ 300mm</p>	<p>SDP-ET</p>  <p>General purpose, Tension available 50/100mm</p>	<p>WD-A</p>  <p>Wire type 250/500/1000mm</p>	<p>DP-5000E</p>  <p>Tape measure type 5000mm</p>
<p>DP-G</p>  <p>Tape measure type 500 ~ 2000mm</p>	<p>FDP-A</p>  <p>Waterproof, LVDT type 10 ~ 100mm</p>	<p>PI</p>  <p>Pi-shape $\pm 2/\pm 5$ mm Gauge length 50 ~ 300mm</p>	<p>CE</p>  <p>Cantilever type 2 ~ 10mm</p>
<p>OU</p>  <p>Ring type 10 ~ 30mm</p>	<p>RA/RA-L</p>  <p>COD (crack opening displacement measurement) 2/5mm For cryogenic temperature (RA-L)</p>	<p>UB/UB-A</p>  <p>COD (crack opening displacement) measurement UB: 2/5mm UB-A: 5mm (ASTM compatible)</p>	



Extensometer	Pressure Transducers		
EDP-A/EDP-B	PW-PA	PWH-PA	PWF-PB/PWFC-PB
 5mm For round specimen: EDP-A For flat plate specimen: EDP-B	 Cavity type, General purpose 100kPa ~ 50MPa	 Cavity type, High capacity 70 ~ 200MPa	 PWF-PB PWFC-PB Flush diaphragm type PWF-PB: 1 ~ 50MPa PWFC-PB: 2 ~ 50MPa (Small)

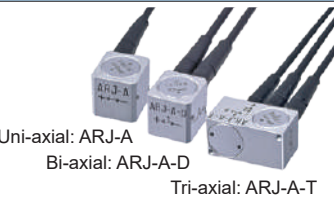

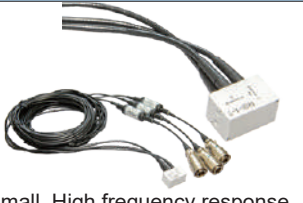

Pressure Transducers			
PW-PAH	PWFD-PB	PWFE-PA	PWFA-PA
 Small, For high temperature use 2 ~ 50MPa Operational temperature: -40 ~ +170°C	 M8 bolt type with flange For high temperature use (+150°C) 2 ~ 20MPa	 M6 bolt type for automotive industries For high temperature use (+150°C) 2 ~ 20MPa	 Amplifier-integrated, Small For high temperature use (+120°C) 2 ~ 20MPa

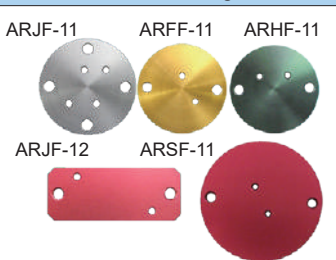

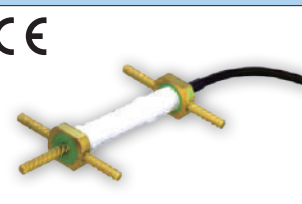
		Acceleration Transducers	
PDA-PB/PDB-PB	PDC-PA/PDD-PA	ARS-A	ARM-A-T
 PDA-PB PDB-PB Miniature 50kPa ~ 3MPa	 PDC-PA PDD-PA Miniature 100/200/300kPa	 High sensitivity 10m/s ²	 Small, Tri-axial X, Y: 100m/s ² , Z: 400m/s ²



ARF-A/ARF-A-T	ARE-A	ARE-A-T	ARH-A
 Small, Low range ARF-A: Uni-axial, 10 ~ 500m/s ² ARF-A-T: Tri-axial, 20 ~ 500m/s ²	 High range 1000 ~ 10000m/s ²	 High range, Tri-axial 1000 ~ 5000m/s ²	 Waterproof, Low range 10 ~ 500m/s ²



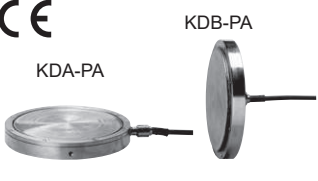

ARJ-A/ARJ-A-D/ARJ-A-T	ARGH-A	ARGH-A-T	ARGL-A
 Uni-axial: ARJ-A Bi-axial: ARJ-A-D Tri-axial: ARJ-A-T Small, High frequency response 50 ~ 2000m/s ²	 Small, High frequency response, High range 500/1000/2000m/s ²	 Small, High frequency response, High range, Tri-axial 500/1000m/s ²	 Small, High frequency response, Low range 20 ~ 200m/s ²

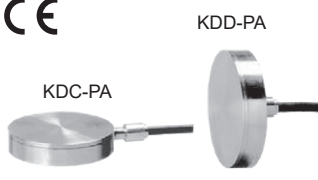
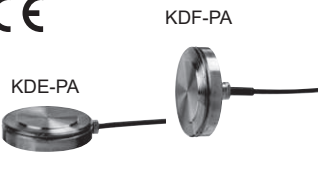
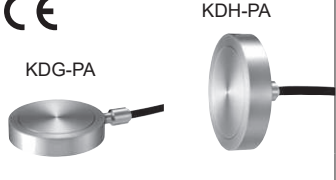
		Strain Transducers	
ARGL-A-T	Transducer Mounting Plates	KM/KM-BT	KM-100HAS
 Small, High frequency response, Low range, Tri-axial 20 ~ 200m/s ²	 ARJF-11 ARFF-11 ARHF-11 ARJF-12 ARSF-11	 ±5000×10 ⁻⁶ strain Thermocouple integrated: KM-BT	 ±5000×10 ⁻⁶ strain

Crack Displacement Transducers	Compressometer		Pore Pressure Gauges
KG-A	CM	CM-H	KPC-PA/KPD-PA
 <p>For concrete structures ±2/±5mm</p>	 <p>Applicable cylindrical concrete specimen Φ10/12.5/15 cm</p>	 <p>For destructive test with dispersion protective cover Applicable cylindrical concrete specimen Φ10cm</p>	 <p>Φ30mm 200kPa ~ 2MPa</p>

Soil Pressure Gauges			Soil Pressure Gauges
KPE-PB	KPG-PA / KPH-PA	PP-200KPA	KDA-PA/KDB-PA
 <p>Small, For model testing 200kPa ~ 2MPa</p>	 <p>Miniature, For model testing 50kPa ~ 200kPa</p>	 <p>PP-200KPA-8H PP-200KPA-8V NEW High sensitivity compact pore pressure gauge 200kPa</p>	 <p>Φ200mm 200kPa ~ 2MPa</p>

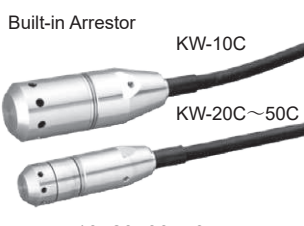
Soil Pressure Gauges			
KDC-PA/KDD-PA	KDE-PA/KDF-PA	KDG-PA/KDH-PA	KDJ-PA/KDK-PA
 <p>Φ100mm 200kPa ~ 2MPa</p>	 <p>Φ50mm 200kPa ~ 2MPa</p>	 <p>Load cell type Φ100mm 200kPa ~ 2MPa</p>	 <p>Load cell type Φ200mm 200kPa ~ 2MPa</p>

Inclinometers	Water Level Meters		Temperature Gauge
KB-AB/KB-AC	IM-10UA / BA	KW-C	KT-110A
 <p>Surface mounting type ±1 ~ ±5° KB-AB: 1-directional KB-AC: 2-directional</p>	 <p>NEW Network Compatible Multi-layer inclinometer IM-10UA/BA type ±10° IM-10UA: 1-directional IM-10BA: 2-directional</p>	 <p>Built-in Arrestor KW-10C KW-20C~50C 10, 20, 30, 50 m</p>	 <p>-30 ~ +80°C 350Ω Full bridge Sensitivity: Approx. 130×10⁻⁶strain/°C</p>







Thermocouples
 <p>Type T, Type K</p>

Data Loggers/Static Strainmeters/Switching Boxes

•Data logger/Static strainmeter

Strain which is considered not to change with time during the measurement is called static strain. Two or more points of static strain can be measured using one strain meter by scanning the input channels, and each strain is obtained as digital value. Automatic

measurement of a large number of measurement point is possible by using dedicated switching boxes together. Recently, performance of data loggers has been greatly improved such as measurement in faster speed and more sophisticated data processing.

Data Logger	Measurement Box	Number of measuring point	Measuring Time [interval for measurement]
High speed • High accuracy • High functionality Data Logger T-ZACCS9 TS-963  Interface: LAN/USB/RS-232C	Built-in Unit	30	High speed : 0.1 seconds (0.1 seconds)/ High accuracy : 0.4 seconds (0.4 seconds)
	T-ZACCS BOX EX-50H	1000	High speed : 0.1 seconds (0.1 seconds)/ High accuracy : 0.4 seconds (0.4 seconds)
	T-ZACCS Unit EU-10H	1000	High speed : 0.1 seconds (0.1 seconds)/ High accuracy : 0.4 seconds (0.4 seconds)
High speed • High accuracy • High functionality Data Logger T-ZACCS9 TS-960  Interface: LAN/USB/RS-232C	Built-in Unit	10	High speed : 0.1 seconds (0.1 seconds)/ High accuracy : 0.4 seconds (0.4 seconds)
	T-ZACCS BOX EX-50H	1000	High speed : 0.1 seconds (0.1 seconds)/ High accuracy : 0.4 seconds (0.4 seconds)
	T-ZACCS Unit EU-10H	1000	High speed : 0.1 seconds (0.1 seconds)/ High accuracy : 0.4 seconds (0.4 seconds)
Data Logger TDS-540  Interface: LAN/USB/RS-232C	IHW-50G	1000	0.4 seconds/1000 points (0.04 seconds/point) [1 second]
	ISW-50G	1000	2 seconds/1000 points (0.04 seconds/point) [3 seconds]
	ASW-50C SSW-50D	1000	80 seconds/1000 points (0.08 seconds/point) [80 seconds]
	Built-in (High speed)	30	0.4 seconds/30 points (0.04 seconds/point) [1 second]
	Built-in (Standard)	30	1.2 seconds/30 points (0.04 seconds/point) [2 second]
T-ZACCS5 Data Logger TS-560  Interface: LAN/USB/RS-232C	IHW-50G	1000	0.4 seconds/1000 points (0.04 seconds/point) [1 second]
	ISW-50G	1000	2 seconds/1000 points (0.04 seconds/point) [3 seconds]
Portable Data Logger TDS-150  Interface: USB/RS-232C LAN (option)	FSW-10	50	4 seconds/50 points (0.08 seconds/point) [4 seconds]
	FSW-10L	50	4 seconds/50 points (0.08 seconds/point) [4 seconds]
Handheld Data Logger TC-32K  Interface: : USB/RS-232C	CSW-5B	5	0.4 seconds/5 points (0.08 seconds/point) [1 second]
	Not used (TC-32K only)	1	0.08 seconds/1 point (0.08 seconds/point) [1 second]

Data loggers are equipped with functions of calculation, storage and processing of measured data in addition to automatic scanning measurement of multiple points. Not only strain but also voltage and temperature are accepted as measurement objects of data loggers.

Data Loggers/Static Strainmeters/Switching Boxes

CE



**High speed • High accuracy • High functionality
Data Logger TS-963**

- Capable of measuring strain gauges, strain gauge transducers, thermocouples, platinum RTD (resistance temperature detector), DC voltage, etc.
- High-speed mode allows measurements every 0.1 sec. (High-speed mode allows measurements every 0.1 sec.)
- Built-in measuring unit capable of monitoring and displaying all 30ch points Our unique next-generation A/D method eliminates noise and realizes highly accurate and stable measurement.
- Measurement data can be recorded in 4GB internal memory, SD card is used as external recording media Equipped with 9-inch wide LCD touch panel
- Comfortable operation with wide widescreen and user-friendly screen configuration Remote data logger functionality enables operation from a web browser

**High speed • High accuracy • High functionality
Data Logger TS-960**



- 1000 points at maximum (2000 points at maximum when temperature-integrated strain gauges are used, +100 Extended channels)
- Our unique next-generation A/D conversion method enables high-speed measurement with high accuracy and stability
- Measurement is possible at intervals of 0.1 seconds in high-speed mode
- High resolution mode (0.1×10^{-6} strain) provided
- Complete compensation method of strain (Comet) provided
- 9-inch IPS LCD wide screen display with wide viewing angle provided
- Automatic measurement (Interval measurement, comparator measurement, alarm measurement, and sampling measurement are available)
- Extended channel function for various inter-channel operations, including rosette analysis provided
- Logical formulas using "IF", "MAX" and "MIN" are available

CE



**Measurement Box
T-ZACCS BOX EX-50H**

- Ultra high-speed field network enables measurement of up to 1000 points in 0.1 second
- Our unique next-generation A/D conversion method enables high-speed measurement with high accuracy and stability. Stable measurement is realized eliminating the influence of power line noise.
- Measurement is possible at intervals of 0.1 seconds in high-speed mode and 0.4 seconds in high-accuracy mode (in 50Hz area) even when thermocouple measurement or high resolution mode is used
- Temperature-integrated strain gauges can be measured with one channel
- Complete compensation method of strain (Comet) provided
- Various check functions are available such as insulation / sensitivity / dispersion of sensor, thermocouple burnout

CE



**Measurement Unit
T-ZACCS EU-10H**

- Measures 1000 points in 0.1 seconds at the fastest by the adoption of ultra high-speed field network
- Highly accurate and stable measurement achieved by the adoption of our unique next-generation A/D conversion method that enables high-speed measurement with high accuracy and stability eliminating the influence of various thermoelectromotive forces, thermal zero shift of amplifier, and power line noise
- In high-accuracy mode, measures 1000 points in 0.4 seconds (in 50Hz area) even for thermocouple measurement and/or using high-resolution mode
- A temperature-integrated strain gauge can be measured using one channel
- Complete compensation method of strain (Comet) provided
- Various check functions (insulation check, sensitivity check, dispersion check, thermocouple burnout check)

CE



**Analog Output Unit
T-ZACCS UNIT EU-10VO**

- Analog output of up to 20 points is possible for one TS-963/960 using two output units
- It can be placed at any position between the data logger and the measurement box



**Digital Displacement Sensor
Measurement Unit T-ZACCS UNIT EU-10D**

- Combined with T-ZACCS9 TS-963/960, digital displacement sensor measurement is available
- Compatible with two types of digital displacement sensors
- No signal degradation because it is handled as a digital signal
- Can be used with T-ZACCS BOX EX-50H, T-ZACCS UNIT EU-10H, and EU-10VO at the same time



**Switching Box Protocol Converter
T-ZACCS + EI-01P**

- T-ZACCS9 TS-963/960 enables measurement of switching box ISW-50G/IHW-50G
- Easy handling with no special settings required
- Corresponding to 1-gauge 4-wire measuring method

NEW



**Repeater
T-ZACCS + EE-00R**

- Extended communication distance between units.
- Connect between T-ZACCS9 and T-ZACCS BOX/T-ZACCS UNIT or between T-ZACCS BOX/T-ZACCS UNIT and T-ZACCS BOX/T-ZACCS UNIT.
- The 100m distance between devices can be extended by another 100m.



**T-ZACCS5
Data Logger TS-560**

- The number of measuring point can be extended up to 1000 points
- Remote data logger function provided
- Color LCD monitor with touch panel for scanning speed of up to 1000 items in 0.4 seconds
- Display can be switched between Japanese and English modes
- SD card, USB memory available
- LAN, USB 2.0, and RS-232C interfaces provided
- High resolution mode (0.1×10^{-6} strain) provided
- Complete compensation method of strain provided
- Both strain and temperature can be measured in one channel using a temperature-integrated strain gauge
- Quarter bridge 4-wire strain measurement available

CE



**Data Logger
TDS-540**

- Measuring point number is 1000 at max.
- Remote data logger function
- Fastest scanning time 0.4s for 1000 points
- Color LCD monitor with touch panel
- Display in Japanese/English switchable
- SD card and USB memory acceptable
- LAN, USB2.0 and RS-232C interface
- High resolution mode of 0.1×10^{-6} strain
- Built-in switching box of 30-ch at max (10-ch standard) with semiconductor relay
- CE marked
- Complete compensation method of strain
- Measures temperature-integrated strain gauge in one channel (strain/temperature)
- 1-gauge 4-wire strain measurement possible

CE



**High speed Switching Box
IHW-50G**

- Electrically isolated from data logger
- Measurement of strain, DC voltage, thermocouple and PtRTD
- Sampling speed is 0.04s/channel 0.4 seconds/1000 channels at the fastest by parallel sampling of built-in ADC
- Surge absorber for lightning protection equipped for each channel as standard
- Connected to data logger by optical fiber or RS-422
- Complete compensation method of strain
- Applicable data logger: TS-963/TS-960/TDS-630/TDS-540

CE



**Switching Box
ISW-50G**

- Electrically isolated from data logger
- Measurement of strain, DC voltage, thermocouple and PtRTD
- Sampling speed is 0.04s/channel 2 seconds/1000 channels at the fastest achieved by built-in ADC
- Surge absorber for lightning protection equipped for each channel as standard
- Connected with data logger by optical fiber or RS-422
- Complete compensation method of strain
- Applicable data logger: TS-963/TS-960/TDS-630/TDS-540

CE

FSW-10



FSW-10L

**Switching Box
FSW-10/FSW-10L**

- 10-channel unit dedicated to combined use with TDS-150
- Five units (50 channels) can be connected at the maximum
- Measurement of strain, DC voltage, thermocouple and Pt-RTD
- 1-gauge 4-wire strain measurement possible
- FSW-10L is smaller in size than FSW-10, as it does not have NDIS receptacle and modular jack
- CE marked

CE



**Portable Data Logger
TDS-150**

- Connectable five channel units (FSW-10/FSW-10L) at the maximum for 50 channels
- Long-term automatic measurement using sleep interval timer
- Low power consumption
- Measurement of strain, DC voltage, thermocouple and Pt-RTD
- Reading of TEDS sensor possible
- Complete compensation method of strain
- USB and RS-232C interface
- Connection of network module possible (factory installed option)
- LAN board (factory installed option)
- CE marked

CE

CSW-5B **CSW-5B-05**



**Switching Box
CSW-5B/CSW-5B-05**

- Measurement of strain, DC voltage, thermocouple and Pt-RTD
- Sensor mode is set from TC-32K
- Connection to terminal is possible either by screwing or soldering
- Number of measuring point is 5

CE



**Handheld Data Logger
TC-32K**

- Measurement of strain, DC voltage, thermocouple and Pt-RTD
- Insulation and resistance measurement function provided to check sensors
- USB and RS-232C interface
- 1-gauge 4-wire strain measurement possible
- Complete compensation method of strain
- Reading of TEDS sensor possible
- Easy connection of cable wires without connector
- Automatic measurement using interval timer
- Multi-point measurement when used with CSW-5B (CSW-5A also acceptable)
- CE marked



**Switching Box
ASW-30C/ASW-50C**

- Measurement of strain, DC voltage and thermocouple
- Sensor mode is set from data logger by the data logger program
- Cascaded to data logger using one Φ 9mm cable
- Connection to terminal is possible either by screwing or soldering
- Complete compensation method of strain
- Applicable data logger: TDS-630/TDS-540/TDS-530/TDS-602/TDS-303

CE



**Switching Box
SSW-50D**

- 1-gauge 4-wire strain measurement possible
- Measurement of strain, DC voltage and thermocouple
- Combined use possible with ASW-50C and SSW
- Complete compensation method of strain
- Cascaded to data logger using one Φ 9mm cable
- Applicable data logger: TDS-630/TDS-540/TDS-530/TDS-602/TDS-303

TML-NET NETWORK MEASUREMENT SYSTEM

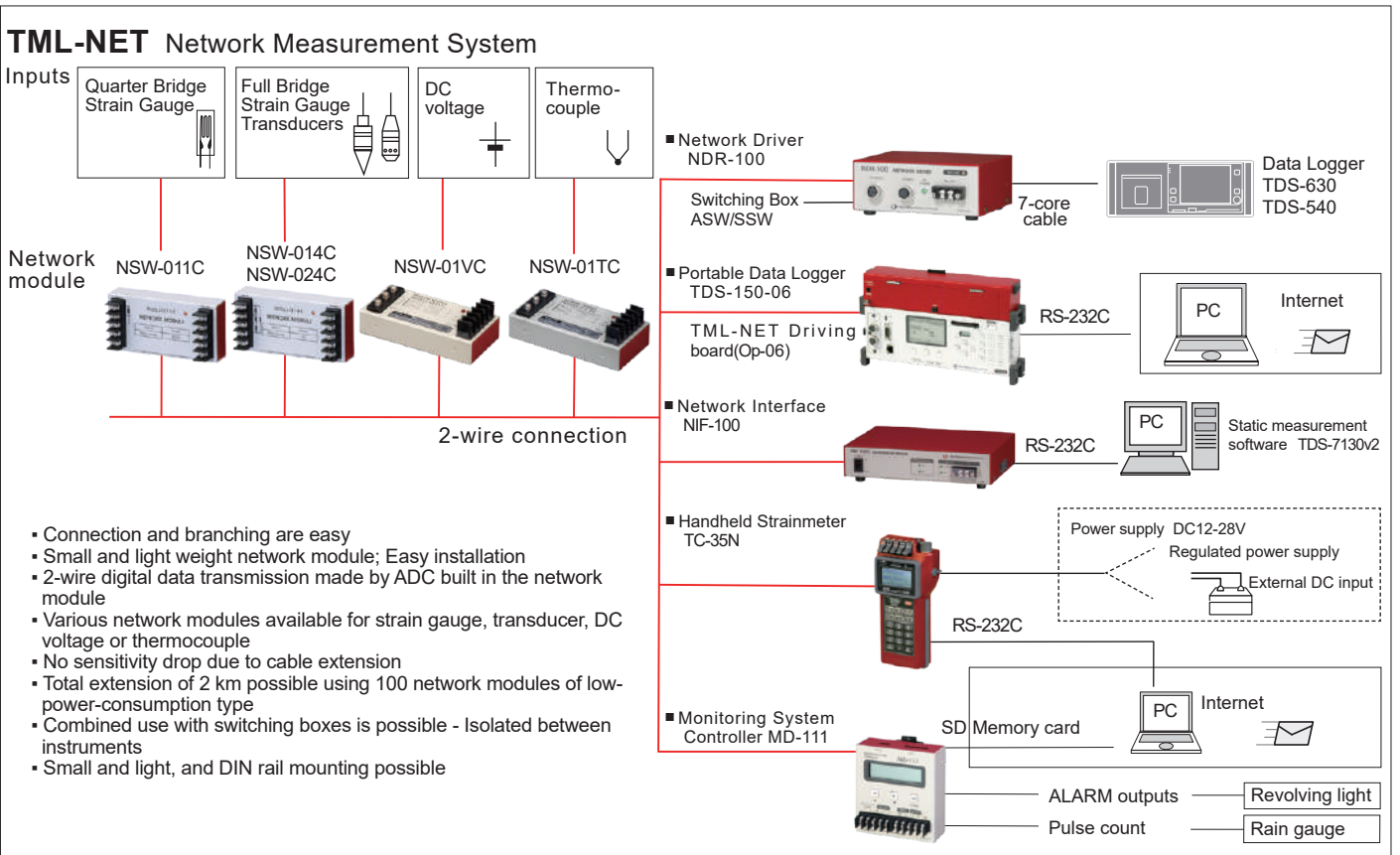

TML-NET NETWORK MEASUREMENT SYSTEM

	<p>Network Driver NDR-100</p> <ul style="list-style-type: none"> Interface for driving network modules from data logger TDS-630 or TDS-540 Number of measuring point is 100 for one unit; By the use of 10 units, measurement of 1000 points is possible Parallel use available with conventional measuring system using SSW/ASW switching box The total distance between data logger and NDR-100 is possible up to 2 km 		<p>Network Interface NIF-100</p> <ul style="list-style-type: none"> Interface for driving network modules directly from computer through RS-232C interface Number of measuring point is 100 Control possible by Static Measurement Software Visual LOG TDS-7130v2
	<p>Monitoring System Controller MD-111</p> <ul style="list-style-type: none"> Configuration of disaster prevention system using alarm output via contact output Automatic measurement using sleep interval timer Counting and recording of rain gauge pulse using contact input Small, light and DIN rail mounting possible Measured data are stored in SD card 		<p>Network Handheld Strainmeter TC-35N</p> <ul style="list-style-type: none"> Small, light and waterproof AA size battery driven Suitable for checking on site and/or configuration of small scale measurement system Control from computer through equipped RS-232C interface Measurement of 5 points or less when internal battery or AC adaptor is used; 100 points or less when external DC input is used Flash memory card usable Sleep interval timer provided
	<p>Strain Quarter Bridge Module NSW-011C</p> <ul style="list-style-type: none"> For quarter bridge 3-wire method 120Ω or 350Ω (specified when ordering) Low power consumption <ul style="list-style-type: none"> During standby 1mA max During measurement 36mA max Measuring range $\pm 30000 \times 10^{-6}$ strain 		<p>Strain Full Bridge Module NSW-014C</p> <ul style="list-style-type: none"> For strain full bridge method Low power consumption <ul style="list-style-type: none"> During standby 1mA max During measurement 36mA max Applicable resistance 120~1000Ω Measuring range $\pm 30000 \times 10^{-6}$ strain
	<p>Strain Full Bridge 2-channel Module NSW-024C</p> <ul style="list-style-type: none"> For strain full bridge method Number of measuring point is 2 <ul style="list-style-type: none"> Connection of 100 modules for measurement of 200 points is possible at the maximum Low power consumption <ul style="list-style-type: none"> During standby 1mA max During measurement 36mA max Applicable resistance 120~1000Ω Measuring range $\pm 30000 \times 10^{-6}$ strain 		<p>Voltage Module NSW-01VC Thermocouple Module NSW-01TC</p> <p>Voltage Module NSW-01VC</p> <ul style="list-style-type: none"> For measurement of DC voltage Measuring range <ul style="list-style-type: none"> V1 ± 2.5V V2 ± 25V <p>Thermocouple Module NSW-01TC</p> <ul style="list-style-type: none"> Applicable thermocouple T <ul style="list-style-type: none"> [JIS C1602-2015] Measuring range $-100 \sim +200^{\circ}$C
	<p>Network Module NSW-01CC</p> <p>A module that counts precipitation, flow rate, quantity, number of vehicles that pass by, frequency of machine operation, and other information with no-voltage contact or open collector input.</p> <p>A built-in backup battery allows to continue counting even when the power supply is not available.</p>		<p>Lightning Protection Unit for TML-NET NNZ-2A</p> <p>Prevents the measuring system from malfunctioning caused by induced lightning</p> <ul style="list-style-type: none"> Surge resistance 100A (8/20 μs impulse) Number of usable units <ul style="list-style-type: none"> NNZ-2A 10 Low power consumption module 100 Cable to be used Exclusive 2-wire shielded cable Total extension distance <ul style="list-style-type: none"> 2 km or less with DC24V power source 1 km or less with DC18V power source

Dynamic Strainmeters

•Dynamic strainmeter

Strain which changes with time is called dynamic strain. A dynamic strainmeter amplifies strain in analog form and outputs to an external recorder. Fundamentally, each one strainmeter and recorder is required for one measurement point. Nowadays, digital dynamic strainmeters are available in multichannel configuration. Their function

is to convert analog signal into digital values at high speed for storage in internal memory and transfer to a computer.

Digital Dynamic Strainmeter

Type	Number of measuring point	Bridge excitation	Frequency response	Interface
DC-204R DC-204Ra	4 4	DC0.5, 2V DC0.5, 2V	DC ~ 10kHz DC ~ 10kHz	USB
DC-004P	4	DC0.5, 2V	DC ~ 2kHz	USB
DH-14A	4	DC0.5, 2V	DC ~ 1kHz	—
DS-50A	50	DC2V	DC ~ 100Hz Depends on the number of connected units	LAN

DH-14A



DC-004P



DC-204R/-204Ra



DS-50A



Multi-Recorder

Type	Number of measuring point	Measurement unit	Frequency response	Interface
TMR-300	80 at maximum	Strain full bridge unit, Strain 1G2G 4G unit, Carrier type strain unit, Voltage input unit, Voltage output unit, Distribution unit	DC ~ 10kHz	LAN, USB

TMR-300 series



Analog Dynamic Strainmeter

Type	Number of measuring point	Bridge excitation	Frequency response
DA-17A	1	0.5, 2Vrms 5kHz	DC ~ 2.5kHz
DA-18A	1	0.5, 2Vrms 5kHz	DC ~ 2.5kHz
DA-37A	1	0.5, 2Vrms 20kHz	DC ~ 10kHz
DA-38A	1	0.5, 2Vrms 20kHz	DC ~ 10kHz

DA-17A DA-18A



DA-37A DA-38A



Carrying case
4-/6-/8- channel



Rack
10-ch

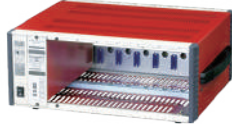



Multi-channel Dynamic Strainmeter DS-50A

- Measurement of 20 sets (1000 channels) is possible at maximum
- 1 kHz sampling at fastest
- Bridge box is integrated for each channel
- Combination of strain unit, voltage unit and thermocouple unit possible
- Measurement software DS-750 supplied as standard accessory

CE

DC-204R



DC-204Ra



Smart Dynamic Strain Recorder DC-204R/DC-204Ra

- Miniature size like postcard
- Sampling speed of 200 kHz at the fastest
- Data recording on compact flash card of 2GByte capacity at the maximum
- Measurement of large strain up to 80000 × 10⁻⁶ (with 0.5V excitation)
- Parallel connection up to 8 units (32 channels)
- Control from computer possible through USB interface
- Data format conforms to commercially available dynamic data analysis software DADiSP/2000
- Control software supplied as standard accessory
- Analog output of ±5V (only for DC-204Ra)
- CE marked

Dynamic Strainmeters



Handheld Dynamic Strainmeter DH-14A

- Handheld dynamic strain meter with 4 measurement channels
- Simultaneous sampling of 4 channels
- 50 μ s (20kHz) sampling at the fastest (for 1-channel mode)
- Measurement of strain, strain gauge type transducer, DC voltage and thermocouple
- Continuous operation of 6 hours at the maximum using four AA-size batteries
- Fine monitoring of numerical values and waveform by color LCD
- Shoulder case is supplied

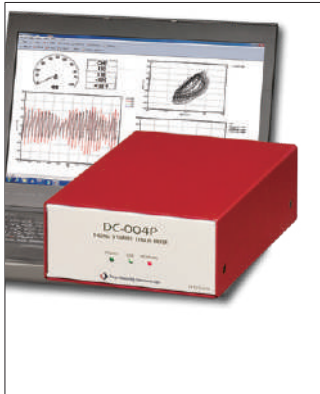

PC Control Dynamic Strainmeter DC-004P

- Simultaneous execution of manual, data trigger and interval measurements
- 50kHz sampling (for 1-channel mode) at the fastest
- Simultaneous sampling of 4 channels (12.5kHz)
- Measurement of 80000×10^{-6} strain possible (with 0.5V excitation)
- Long term recording possible by directly saving into personal computer
- 4-channel model and 2-channel model are available
- Measured data conform to DADISP format
- TEDS compatible
- Control software (DC-7004P) supplied as standard accessory



Dynamic Strainmeter DA-37A/DA-38A

- High frequency response of 10kHz
- Digital sensitivity setting method
- Electronic automatic balancing
- Isolation between input and output
- Automatic tracking capacity balancing
- Dual outputs
- Driven either by AC or DC power source
- Two ways of display : level meter and digital value (DA-38A)
- Digital monitor function (DA-37)
- Computer control available when mounted in LAN compatible carrying case (DA-37A)

DA-37A DA-38A



Dynamic Strainmeter DA-17A/DA-18A

- Frequency response of 2.5kHz
- Digital sensitivity setting method
- Electronic automatic balancing
- Isolation between input and output
- Automatic tracking capacity balancing
- Digital monitor function incorporated
- Dual outputs
- Built-in low-pass filter
- Check of insulation resistance of strain gauge bridge possible (DA-17A)
- External control of balancing and calibration output
- Computer control available when mounted in LAN compatible carrying case (DA-17A)
- Compatible with TEDS (DA-18A)

DA-17A DA-18A



Thermocouple Adaptor TA-01KT

- Small and light
- No external power source required
- Built-in reference junction
- Isolation between input and output
- Built-in digital linearizer provides better linearity than analog linearizer
- Burnout detection function provided
- Calibration output function for setting strainmeter sensitivity

[Applicable strainmeter] Dynamic strainmeter with DC bridge excitation
DC-204R/DC-204Ra, DC-004P, DH-14A, TMR-300



Bridge Box SB-120B/SB-350B

- Applicable to every connection method Quarter bridge 2-wire, Quarter bridge 3-wire, Opposite-arm half bridge, Opposite-arm half bridge 3-wire (SB-120B: 120 Ω , SB-350B: 350 Ω), Half bridge, Full bridge (60~1000 Ω)
- Connecting terminal: Dual use for screwing and soldering



Bridge Box SB-120SB-8/SB-120SB-10

- Number of measuring point
SB-120SB-2: 2
SB-120SB-4: 4
SB-120SB-6: 6
SB-120SB-8: 8
SB-120SB-10: 10
- Quarter Bridge 2-wire: 120 Ω (with connection between B and C)
Quarter Bridge 3-wire: 120 Ω
Half Bridge, Full Bridge: 60~1000 Ω
- Connecting terminal: Screwing, Soldering, NDIS connector receptacle
- Input connector
Terminal M3 \times 5P terminal, Binding head screw
Connector NDIS 7-pin connector

SB-120SB-8



Bridge Box Quarter bridge 2-wire available SB-122A

- Number of measuring point
SB-122A-2: 2
SB-122A-4: 4
SB-122A-6: 6
SB-122A-8: 8
SB-122A-10: 10
- Quarter Bridge 2-wire, Quarter Bridge 3-wire: 120 Ω
Half Bridge, Full Bridge: 60~1000 Ω
- Connecting terminal: Dual use for screwing and soldering
- Input connector
Terminal M3 \times 5P terminal, Binding head screw \times 2
- Switcher: Small toggle switch

SB-122A-2



Bridge Box SB-128A/SB-128A-10/SB-358A

- Number of measuring point
SB-128A/SB-358A: 8
SB-128A-10: 10
- Applicable to every connection method
Quarter bridge 2-wire, Quarter bridge 3-wire, Opposite-arm half bridge, Opposite-arm half bridge 3-wire (SB-128A: 120 Ω , SB-358A: 350 Ω), Half bridge, Full bridge (60~1000 Ω)
- Connecting terminal: Dual use for screwing and soldering

SB-128A-8

Dynamic Strainmeters

CE



SB-120PY-2

Bridge Box for post-yield measurement SB-120PY

- Number of measuring point
SB-120PY-2: 2 SB-120PY-4: 4
SB-120PY-6: 6 SB-120PY-8: 8
SB-120PY-10: 10
- Normal measurement
Quarter Bridge 2-wire: 120 Ω
(with connection between B and C)
Quarter Bridge 3-wire: 120 Ω
Half Bridge, Full Bridge: 60~1000 Ω
- Post-yield (large strain) measurement
Quarter Bridge 2-wire: 120 Ω
(with connection between B and C)
Quarter Bridge 3-wire: 120 Ω
Half Bridge, Full Bridge: 60~1000 Ω
- Connecting terminal: Dual use for screwing and soldering
- Input connector: M3×5P terminal, Binding head screw

CE



Bridge Box Quarter bridge 2-wire available SB-123A/SB-353A

- Applicable to every connection method
Quarter bridge 2-wire, Quarter bridge 3-wire, Opposite-arm half bridge, Opposite-arm half bridge 3-wire
120 Ω : SB-123A
350 Ω : SB-353A
- Half bridge, Full bridge: 60~1000Ω
- Switcher: Small slide switch
- Connecting terminal: Clamping type fast connection terminal

CE



Bridge Box SB-120DG/SB-350DG

- Number of measuring point: 1
- Connected to strain meter by the NDIS 7-pin plug; Connection cable is not necessary
- Quarter Bridge 2-wire
120 Ω: SB-120DG-1R2
350 Ω: SB-350DG-1R2
- Quarter Bridge 3-wire
120 Ω: SB-120DG-1R3
350 Ω: SB-350DG-1R3
- Quarter Bridge 4-wire
120-1000Ω: SB-120DG-4R
- Connecting terminal: Clamping type fast connection terminal



P-4B

P-8AL



Carrying Case P-B LAN compatible: P-AL

- Used to configure multi-channel system with DA series dynamic strainmeters. Each case is equipped with a power switch, calibration switch and balancing button for simultaneous control of all channels.
- P-4B: 4-channel P-6B: 6-channel
P-8B: 8-channel P-10B: 10-channel
- LAN compatible carrying case P-AL
- Applicable dynamic strainmeter
DA-37A/DA-17A
- Controls each setting such as sensitivity and low pass filter, balancing, calibration and acquisition of set and monitor values from computer through LAN.
- P-4AL: 4-channel P-6AL: 6-channel
P-8AL: 8-channel P-10AL: 10-channel

Fast Connecting Terminal SB-0T1B



These terminals enable fast connection and disconnection of lead wires. They are mounted on the input terminal of switching box or bridge box (SB-120SB, SB-121A, SB-120PY, SB-122A). One terminal is used for one lead wire. (One set contains five terminals.)

Multi-Recorder TMR-300 series

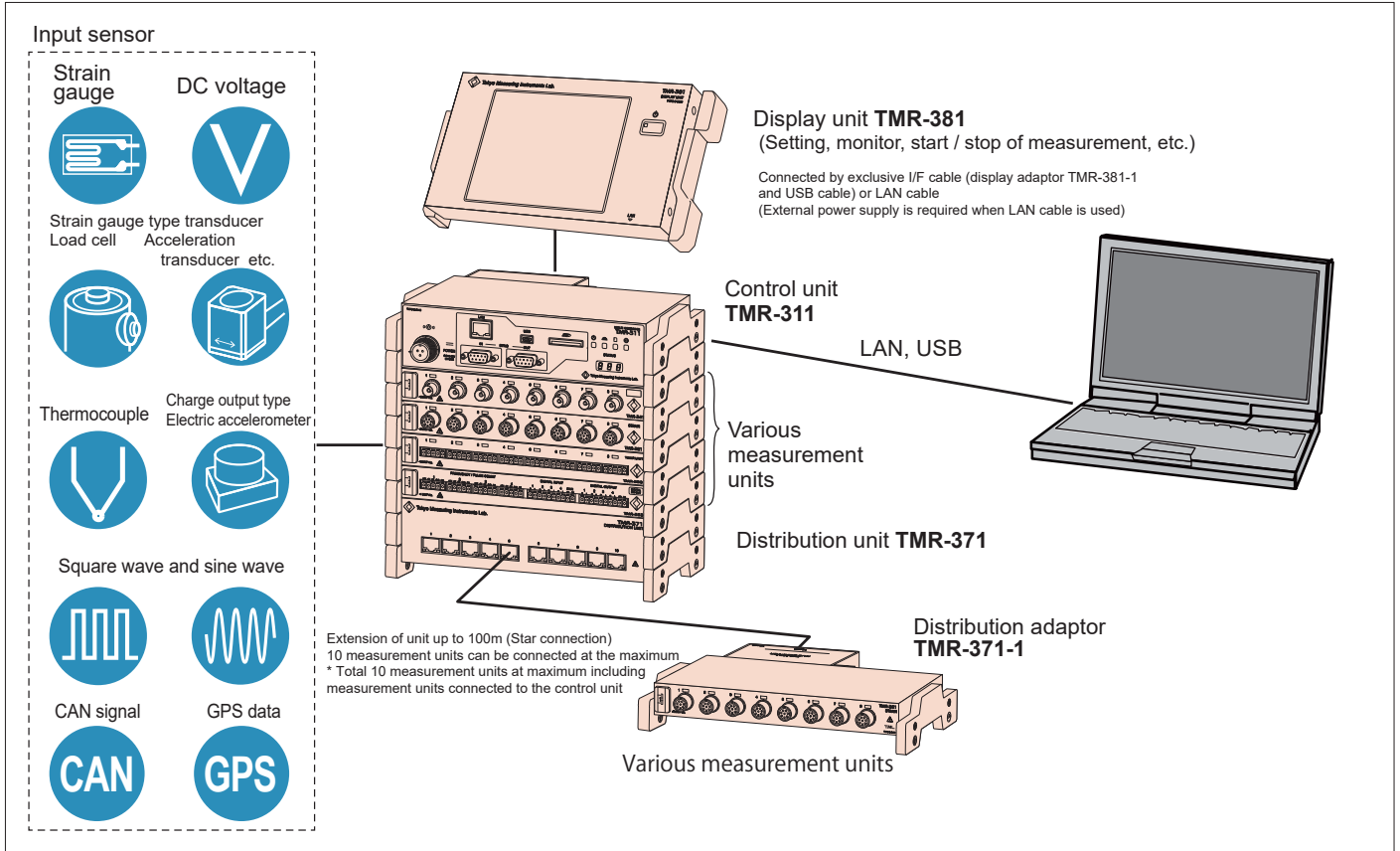

Control Unit TMR-311

- 80 measuring points at the maximum
- High speed sampling of 100kHz
- Vibration resistance and small size suitable to measurement on vehicles
- Driven by DC power source; most suited to use on vehicles
- Equipped with UPS circuit; data storage in the case of power failure and automatic restart after power recovery
- USB and LAN provided
- Unit number is checked and changed easily
- High resolution mode provided
- Extension between units is possible
- Synchronization of four control units at the maximum, Extension between control units up to 100m

Frequency analysis library TMR-311-01 (Options for TMR-311)

- Installed in addition to the standard software of the TMR-311 control unit (optional)
- Estimation of fatigue life of materials
- Measuring the behavior of structures in operation
- Frequency analysis method
Maximum/minimum value method, Amplitude method, Time method Level crossing method, Rain flow method

Strain Full Bridge Unit TMR-321

- Measurement unit for strain in full bridge method
- Number of measuring point: 8
- Input: Strain (120~1000 Ω)
- Voltage measurement possible using attenuator cable [CR-4010]

Strain 1G2G4G Unit TMR-322

- Measurement of quarter, half and full bridge method by the use of exclusive miniature bridge box
- Number of measuring point: 8
- Input: Strain (120~1000 Ω)
- Exclusive bridge box SB-120T or SB-350T 8 pcs. (to be selected when ordering)

Carrier type Strain Unit TMR-323

- Carrier wave bridge excitation that is resistive to noise
- Number of measuring point: 8
- Carrier wave frequency: 5kHz
- 8 channels for one unit; Up to 80 channels is possible for one control unit



Voltage Input Unit TMR-331

- Measurement unit for voltage
- Number of measuring point: 8
- Input: Voltage
- Range: ±52V, ±20V, ±10V, ±5V, ±1V
- Isolated between channels

Multi-Recorder TMR-300 series

	<p>Thermocouple/Voltage Unit TMR-332</p> <ul style="list-style-type: none"> • Thermocouple/Voltage measurement • 8 measuring channels • Input : Thermocouple, Voltage (T,K,J) • Isolated between channels 	<p>CE</p> 	<p>Voltage Output Unit TMR-341</p> <ul style="list-style-type: none"> • Voltage output of measured data obtained by other measurement unit • Number of output point: 8 (BNC connector) • Measurement point for output can be set optionally • Output of calculation result of addition, subtraction or averaging of up to 4 points
<p>NEW</p> 	<p>CAN Unit TMR-351</p> <ul style="list-style-type: none"> • Built-in CAN interface enables data recording and output from CAN bus • Simultaneous measurement of vehicle integrated control signals, acceleration, torque, and stress is possible, enabling control system analysis 		<p>Digital I/O Unit TMR-353</p> <ul style="list-style-type: none"> • Digital pulse signal counting and frequency conversion • Digital input/output necessary for various measurements, such as trigger signal input, sampling lock signal input, and alarm (upper/lower limit setting) output, are available • Power is supplied from the control unit
<p>NEW</p> 	<p>GPS Measurement Unit TMR-354</p> <ul style="list-style-type: none"> • Recording of positioning information from GPS and other positioning satellite systems and time synchronization with GPS is also possible • Location information enables the operator to monitor behavior during long-distance transportation, and accurate time data enables timing synchronization with other equipment and video images 		<p>Charge Amplifier Unit TMR-361</p> <ul style="list-style-type: none"> • Number of measurement points: 4 points • Charge Output Piezoelectric Accelerometer Measurements • Power is supplied from the control unit
	<p>Distribution Unit TMR-371</p> <ul style="list-style-type: none"> • Measurement units can be distributed in star-connection • Number of connection of measurement unit is 10 at maximum • Extension between control unit (distribution unit) and measurement unit (distribution adaptor) is possible up to 100 meters • Power is supplied from control unit 		<p>Distribution Adaptor TMR-371-1</p> <ul style="list-style-type: none"> • One measurement unit is connected to one distribution adaptor • Driven by power supply from distribution unit; no external power source is required
	<p>Synchronization unit TMR-372</p> <ul style="list-style-type: none"> • Synchronous measurement with TMR-200 series • Number of TMR-211 connections: Max. 3 units 	<p>CE</p> 	<p>Display Unit TMR-381</p> <ul style="list-style-type: none"> • Built-in Color TFT LCD display with touch screen • Display of various monitors (T-Y Sweep / Y-T Cont. / X-Y / Numeral) are possible • Settings and measurement control of various units (balancing / start and stop of measurement / automatic measurement setting) and display file management are possible

Digital Indicators - Strain Calibrators

	<p>Digital Indicator TD-98A</p> <ul style="list-style-type: none"> • Processing of 2000 times/second • Analog monitor output • Large-size and easy-to-view color LCD • Graphic display possible • High/Low limit setting possible • Touch panel with excellent operability • Various hold functions • Two hold modes are available at the same time 	<p>CE</p> 	<p>Digital Indicator TD-96A</p> <ul style="list-style-type: none"> • Processing of 4000 times/second • Color graphic display • High/Low, High/High, Low/Low limit setting possible • Various hold functions • Easy setting with TEDS function • Remote sensing available • Voltage/current output possible • Direct strain measurement mode • DIN conforming design suitable for mounting on testing machine • CE marked
---	--	---	---

Digital Indicators ▪ Strain Calibrators



**Digital Indicator
TD-91B/TD-91BB**

- Small and lightweight
- Analog peak hold and upper/lower limit functions
- Wide zero-adjustment range
- Easy operation using jog dial
- Direct reading in physical quantity by calibration with equivalent input value
- Easy-to-see monitor display with wide viewing angle
- Voltage/current output
- Panel mounting type (TD-91BB is desktop type)



**T-ZACCS3
Pocket Load Meter MM-014L**

- Direct reading measurement of Load, displacement, etc.
- Reflective color LCD for clear visibility outdoors
- Parameters for up to 20 transducers can be set
- Batch measurement of coefficients, units, decimal points, and sensor types by "Sensor ID"
- Compatible with TEDS sensor
- Peak hold function
- Simultaneous display of monitor value and peak value
- Equipped with data memory
- SD card available



**T-ZACCS3
Pocket Data Logger MM-014/MM-01T/MM-01V**

- Measuring instruments for strain gauge type transducers only
- Reflective color LCD for clear visibility outdoors
- Long battery life (8 hours continuous)
- Equipped with sleep interval function
- Batch measurement of coefficients, units, decimal points, and sensor types by "Sensor ID"
- Compatible with TEDS sensor
- Data memory capable of recording up to 10000 data
- SD card available
- MM-01V for voltage measurement and MM-01T for thermocouple measurement are available



**High Precision Digital Indicator
TD-30L**

- Excellent accuracy and stability
- Resolution of 0.01×10^{-6} strain at the highest
- Parameters of eight transducers can be registered and switched to read
- Remote sensing available
- TEDS transducer compatible
- RS-232C and LAN are provided for interface



**Strain Calibrator
CB-2RL**

- Bridge resistance is 120Ω or 350Ω (to be selected when ordering)
- Two calibration values available (to be selected when ordering)
- Calibration with quarter bridge, quarter bridge 3-wire, half bridge and full bridge method is possible (selected by the change of connection)



**Strain Calibrator
CBA-2310A**

- Computer control possible (On-line calibration through GP-IB)
- Generation of simulative dynamic strain
- High resolution 0.1×10^{-6} strain or $1/100000$
- Remote sensing available
- Simultaneous calibration of up to 10 numbers of data logger, dynamic strainmeter or switching box.
- Excellent operability



**Strain Calibrator
CBA-131A**

- RS-232C provided for computer control
- Exclusive for full bridge method
- Wide calibration range ($\pm 1000000 \times 10^{-6}$ strain)
- High resolution 0.1×10^{-6} strain or $1/100000$ at the highest
- Excellent stability
- Generation of simulative dynamic strain for checking frequency response of dynamic strainmeter
- Also usable as a standard voltage source of $\pm 20V$ output (with 0.1mV resolution)



**Strain Calibrator
CBM-A**

CBM-123A
CBM-122A

CBM-122A(120Ω) / CBM-352A(350Ω)
For calibration with full bridge method
CBM-123A(120Ω) / CBM-353A(350Ω)
For calibration with quarter bridge, quarter bridge 3-wire, half bridge and full bridge methods

Parallel Connection Box



**Parallel Connection Box
JB-2/JB-4**

- Used to average the outputs of two or four transducers by parallel connection
- Number of input
 - JB-2: 2 points
 - JB-4: 4 points
- Measures average value in combination use with digital indicator or data logger

Power Cables - Data Cables - Attenuator Cables

CR-01 AC power cable Sideways 3P(P) - 3P(J) 3 meters



Data logger TS-963, TS-960, TDS-540
Switching box SSW, ASW, ISW, IHW
Digital indicator TD-30L
Dynamic strainmeter DS-50A
Strain calibrator CBA-131A

CR-06 AC power cable 3P(P) - 12P(J) 3 meters



Dynamic strainmeter DA/DC series
NB: When mounted in carrying case or mounting rack, CR-01 is used.

CR-02 AC power cable Straight 3P(P) - 3P(J) 2 meters



Dynamic strainmeter DRA-162B
Strain calibrator CBA-2310A

CR-11 DC power cable 3P(J) - 12V cigarette 5 meters



Power supply from cigar lighter receptacle in automobile
Multi-recorder TMR-311

CR-30 Output cable BNC - Banana plug 1.5 meters



Dynamic strainmeter DRA, DA, DC series
Multi-recorder Voltage output unit TMR-331/-341

CR-20 Ground wire 5 meters



Various Data loggers

CR-4010 Attenuator cable



Attenuation ratio 1/1000
Voltage measurement using Smart dynamic strain recorder DC-204R/DC-204Ra or Multi-recorder Strain full bridge unit TMR-321

CR-31 Output cable BNC - BNC 1.5 meters



Dynamic strainmeter DA series
Multi-recorder Voltage output unit TMR-341

CR-4120 Attenuator cable



Attenuation ratio 1/100
Voltage measurement using Dynamic strainmeter DC-004P or DH-14A

CR-4110 Attenuator cable



Attenuation ratio 1/1000
Voltage measurement using Dynamic strainmeter DC-004P or DH-14A

CR-6187 USB cable mini A-B 1.8 meters



Connection of Data logger TDS-540/TDS-150, TC-32K or Dynamic strainmeter DC-004P with computer

CR-892M EX Connection cable



Connection between the measurement box EX-50H and the data logger TS-963/-960, and between the EX-50H and each other
The lengths below are also available.
CR-892M(2m), CR-895M(5m), CR-8901(10m), CR-8902(20m), CR-8905(50m), CR-8910(100m)

CR-5360 RS-232C cable Dsub9P(J) - Dsub9P(J) cross 1.5 meters



Connection between Data logger TDS-540 or Indicator TC-351F and Computer interface RS-232C

CR-800 Extension cable NDIS(P) - NDIS(J) 7-core 5 meters



Connection between Switching box SSW or ASW series and Data logger, or between two switching boxes
The lengths below are also available.
CR-801(10m), CR-802(20m), CR-803(30m), CR-805(50m), CR-810(100m), CR-812(200m)

CR-832M Extension cable for ISW/IHW RS-422 2 meters



Connection between Switching box ISW or IHW and Data logger TS-560/TDS-540, or between two ISW/IHW switching boxes

CR-842M Extension optical fiber cable for ISW/IHW 2 meters



Connection between Switching box ISW or IHW and Data logger TS-560/TDS-540, or between two ISW/IHW switching boxes
The lengths below are also available.
CR-845M(5m), CR-8401(10m), CR-8402(20m), CR-8405(50m), CR-8410(100m)

Power Cables ▪ Data Cables ▪ Attenuator Cables

CR-1869 AC adaptor (AC 100 ~ 240V) 1.5 meters



For Handheld data logger TC-32K or Portable data logger TDS-150

CR-5810 1-gauge 4-wire adaptor



This adaptor is used for connecting 1-gauge 4-wire strain gauge with modular plug to the handheld data logger TC-32K.

KOR Precision Fixed Resistor

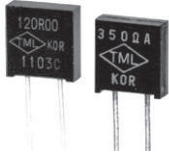

This is used for configuration of bridge circuit. Resistance value: 120Ω, 350Ω

Connectors

NDIS Plug ▪ Jack

Plug
PRC03-12A10-7M



Jack
PRC03-32A10-7F



These are 7-pin plug and jack. Connection and disconnection is made easily and quickly. It is used on the end of supplied cable or extension cable of transducer, switching box (ASW, SSW) or bridge box.

BNC Connector JJ



Used for relaying two BNC plugs

NDIS Receptacle (Square flange)

Receptacle
PRC03-21A10-7F



This is a receptacle mating with NDIS plug. It is used for the input connector of dynamic strainmeter (DA series).

BNC Connector JPJ



Used for dividing the BNC output of dynamic strainmeter into two outputs

NDIS Receptacle (Bulkhead)

Receptacle
PRC03-23A10-7F



This is a receptacle mating with NDIS plug. It is used for the input connector of switching box (optional for some models).

BNC Connector JJJ



Used for dividing the BNC plug into two

Watertight Plug ▪ Jack

Watertight plug
TC1108-12A10-7M



Watertight jack
TC1108-32A10-7F



These are 7-pin watertight plug and jack. The ring of the plug has a thread on its inner surface to mate with watertight jack or watertight receptacle. It is used on the end of the supplied cable or extension cable of transducer (on transducer side).

Plug for Smart dynamic strain recorder and Multi-recorder

Plug
PRC07-P8M



This is a miniature plug for connecting input to Smart dynamic strain recorder DC-204R or Multi-recorder TMR-321.

Watertight Receptacle

Watertight receptacle
TC1108-23A-10-7F



This is a receptacle mating with watertight plug. It is used for the input/output connector of load cell or pressure transducer (on transducer main body).

AUTOMOTIVE MEASURING SYSTEM

Among the mechanism in an automobile, there are many items to be measured such as the maintenance of the engine and the electrical components, the effectiveness of power transfer to the drive wheels, the driving stability that determines the riding comfort, and the braking performance that controls the driving of a car. Our automotive measuring products allow you to build an all-in-one system for in-vehicle measurement, incorporating even a recorder and a computer.

●Powertrain (Power transfer)

Wheel Torque Transducer LTW Series
6-Component Wheel Force Transducer SLW Series

●Suspension (Driving stability)

6-Component Wheel Force Transducer SLW Series

●Braking

Wheel Torque Transducer LTW Series
6-Component Wheel Force Transducer SLW Series
Braking Pedal Force Transducer MLA-NA

Braking Pedal Force Transducer MLA-NA

This is a load cell to measure the brake pedal force. It can easily be attached without modifying the pedal.



Frictional Torque Sensor System FGDH-2A/-3A



(only for
FGDH-3A)



Installed on a car's driving shaft and measures torque by digital transmission and reception.

Steering Torque/Angle Transducer HLA-50B

By attaching the transducer to the steering column of a passenger car, steering torque and steering angle are measured.

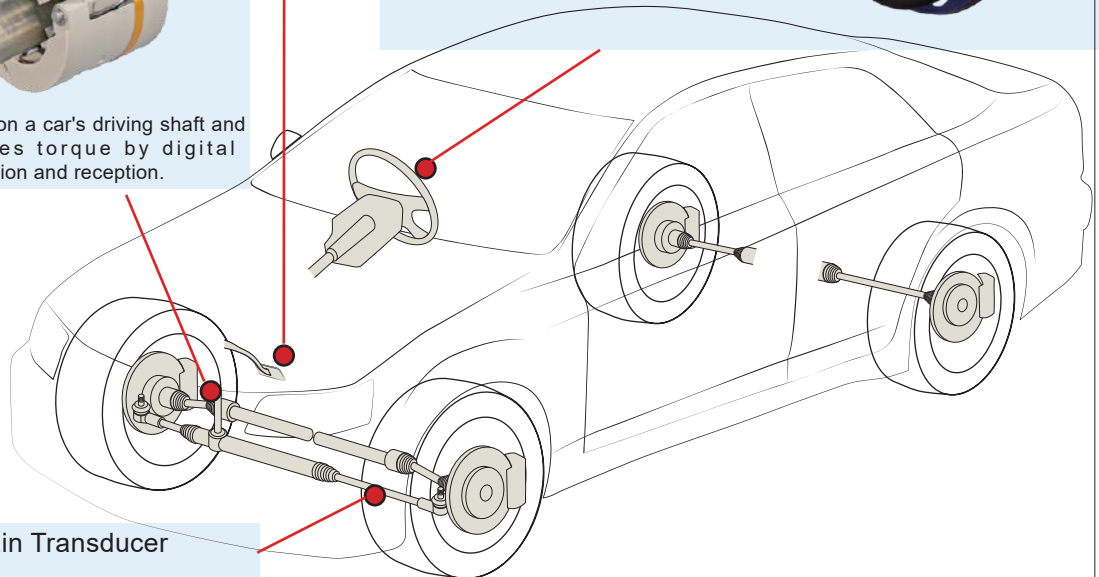

Frictional type Axial Strain Transducer FGAH-1B-R/-H

Measures tensile force and compressive force on the steering tie-rod.

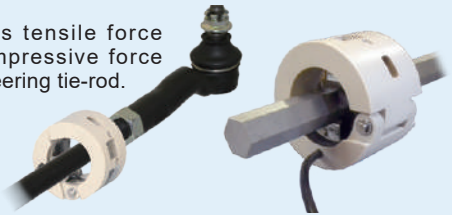

Wheel Torque Transducer LTW-NA (Slip-ring type)

The wheel torque measuring system measures the driving torque and braking torque while driving in analog output form. It incorporates an encoder and can measure the rotation speed in addition to the torque.



6-Component Wheel Force Transducer SLW-F / SLW-NC (Slip-ring type)

The signals sent from the 6-component wheel force transducer (SLW series) attached to the axle shaft are amplified by the exclusive 6-component wheel force analyzer (MFT) to be converted into digital values. The digitized measured values are used to perform real-time computational correction for the crosstalk correction between component forces, the rotation correction to cancel the rotational influence on the transducer, and the moment position correction. After the correction, forces of forth/back (F_x), right/left (F_y) and vertical (F_z), and moment (M_x , M_y , M_z) around each force axis are output in analog form.

AUTOMOTIVE MEASURING SYSTEM

Frictional Torque Sensor System

FGDH-3A-40/50

FGDH-3A-30/40

FGDH-3A



■FGDH-3A

- 2.4GHz band is used for wireless communication; installation of antenna is easy
- Three models are available for applicable shaft diameter: $\Phi 20 \sim 30\text{mm}$, $\Phi 30 \sim 40\text{mm}$, $\Phi 40 \sim 50\text{mm}$
- No bonding is required because frictional strain gauges are used
- The use of digital transmitting and receiving system provides excellent noise resistance and eliminates the need of wiring works
- Easy-to-use rechargeable power supply
- Sleep function provided

FGDH-3A

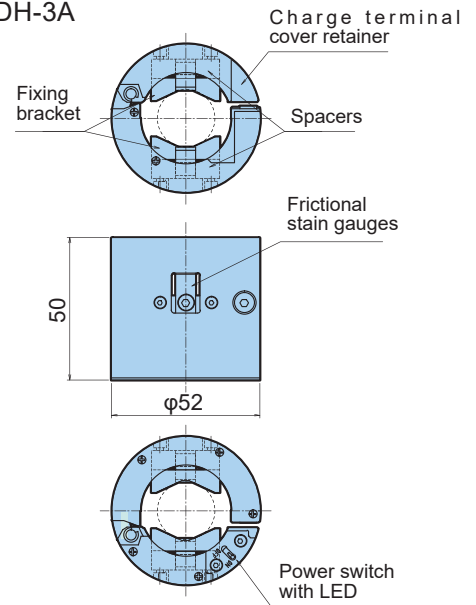

Unit : mm

FGDH-2A



■FGDH-2A

- No gluing required due to the use of friction type gauges
- Adoption of digital transmission/reception system, Resistant to noise, no wiring required
- Compatible with drive shafts of different diameters ($\phi 20\text{-}30\text{mm}$)
- Easy-to-use rechargeable type

Frictional Torque Sensor FGDH
Protective Cover FGDHF-61/62/63

Protection ratings:
IP51 equivalent

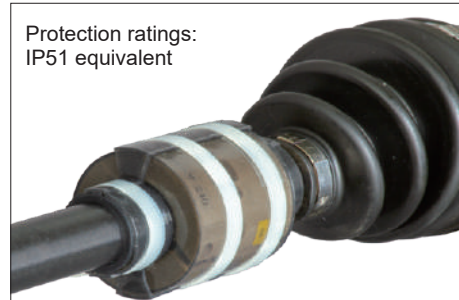

Type	Compatible models	Attached adapters (2 each)	Shaft diameter
FGDHF-61	FGDH-3A	$\phi 29/27/25/23/21$	$\phi 20 \sim 30\text{mm}$
FGDHF-62	FGDH-3A-30/40	$\phi 39/37/35/33/31$	$\phi 30 \sim 40\text{mm}$
FGDHF-63	FGDH-3A-40/50	$\phi 49/47/45/43/41$	$\phi 40 \sim 50\text{mm}$

Steering Torque/Angle Transducer

HLA-50B



HLA-50B

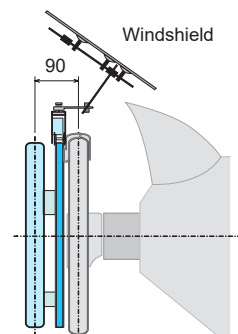
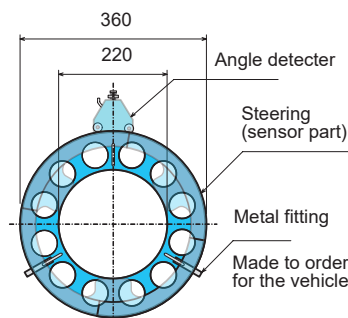

Unit : mm

- Installation possible on cars of various types (applicable to outer diameter of $240 \sim 400\text{mm}$)
- Easy installation and removal
- Excellent operability
- Steering torque is detected by strain gauges and output by digital telemetry

AUTOMOTIVE MEASURING SYSTEM

Frictional type Axial Strain Transducer

FGAH-1B-R (for round shaft) / FGAH-1B-H (for hexagonal shaft)



- Mounted on existing shaft without detaching or modifying the shaft
- Applicable to hexagonal shaft (FGAH-1B-H)
- Applicable shaft dimension is 10~25mm in diameter (round) or 13~25mm in width across flats (hexagonal) (spacers and fixing brackets for the specified dimension are required)
- Small and light; easily installed even in a small space
- Bonding of strain gauge is not required because frictional strain gauges are used; Reusable after detached from the shaft



6-Component Wheel Force Measuring System

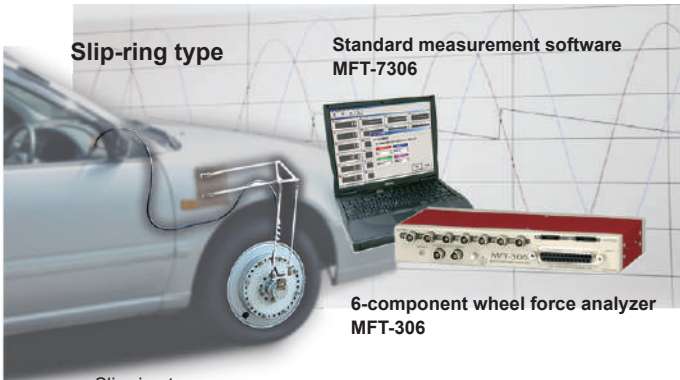

Slip-ring type

Standard measurement software
MFT-7306

6-component wheel force analyzer
MFT-306

Slip-ring type
6-component wheel force
transducer
SLW-NF/SLW-NC

6-Component Wheel Force Transducer SLW-NF
Fx, Fy, Fz : 25kN Mx, My, Mz : 4kN-m

6-Component Wheel Force Transducer SLW-NC
Fx, Fy, Fz : 20/30kN Mx, My, Mz : 3/6kN-m

- High accuracy
- Light weight
- Applicable to various types of cars using exclusive rim and hub adaptor
- Easy installation to actual car
- Waterproof construction of this transducer allows driving in the rain

6-Component Wheel Force Analyzer MFT-306

- Constructed small and light to save the installation space
- High speed operation of correction of mutual interference and rotation
- Voltage output of 6-component data and tire rotation
- Forward and backward measurement possible by the encoder
- Property data of 6-component wheel force transducer are set by a computer
- Control of up to four analyzers is possible
- Control software MFT-7306 is available as standard accessory

Wheel Torque Measuring System

Slip-ring and Encoder Integrated



**Wheel force transducer
with built-in slip-ring and encoder**

SPECIAL PURPOSE MEASURING SYSTEM

Small FWD System FWD-Light

Our Small FWD System - FWD-Light features excellent portability with its compact size, compared to conventional FWD which is large sized and installed on a vehicle. In the small FWD system, the weight is lifted up and then dropped by free fall to generate impact load in the subgrade. The generated load and displacement at that time are measured by the load cell and the acceleration transducer. Displacement is obtained by integrating the acceleration twice. The system is mostly suited to evaluation of subgrade stiffness, evaluation of pavement design for light traffic, and knowing the bearing condition of subgrade.

This system utilizes our original 2-wire network technique to transfer the measured data to the indicator TC-351F. The indicator displays various analysis results and records them in the memory card. The equipped RS-232C interface enables transfer of the data to a computer.



Small FWD System



Protection of Strain Measuring System from Lightning

Arrester

These are used to protect the instruments and transducers from induced lightning.

If a vicinity of the transducers or the cables is struck by lightning, a surge current is induced in the cable, even if the transducers or the cables are not directly struck by lightning. The surge current may cause high voltage in the cable, thus causing damages in the transducers and/or the instruments.

The arrester NZ-7C is connected to the extension cable between the data logger and the switching box. The arrester NZ-6B is connected to the extension cable between the transducer and the switching box. These arresters work to route the surge current to ground when it occurs, so that the surge current does not cause damage in the transducer or the instrument.

Arrester for TML-NET NNZ-2A

The NNZ-2A is used for protecting TML-NET network measurement system from induced lightning. They are connected to both ends of the extended network line. When the network system turns into measurement standby state, it automatically disconnects the network line to prevent induced current and protect the network driver and the network module.

NZ-6B

- Large discharge capability
- Equalized discharge circuit
- Fully waterproof



NZ-7C

- Cable connection is possible either by NDIS connector or soldering
- Equipped with power receiving terminal with for easy connection of power source for switching box



Avoids malfunction of measurement system caused by induced lightning

- Automatically disconnects network line during standby status to prevent induced current
- Power is supplied from the network line
- Monitors network line voltage and network module current, and breaks the circuit instantly if abnormality occurs



MEASUREMENT SOFTWARE Visual LOG

Static Measurement Software TDS-7130v2

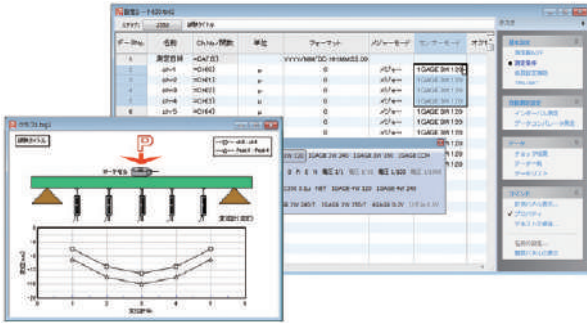

Software for static measurement using our data loggers
 Applicable data logger: TS-963/TS-960/TS-560/TDS-630/TDS-540/TDS-530/
 TDS-150/NIF-100/TC-35N
 Operating environment

OS: MS Windows 7(SP1) / 8.1 / 10 / 11
 Interface: LAN, GP-IB, RS-232C, USB (Depends on data logger type)
 Memory: Free space of 10MByte or more
 HDD: Free space of 3MByte or more (when setting up)

- Continuous monitoring measurement, Interval measurement, Data comparator measurement, Initial measurement, Alarm measurement, External trigger measurement
- Maximum number of measuring points: 4,000
- Maximum number of measuring times: 50,000 ~ 20,000,000
- Stroke change: Settings of measurement start point and measurement stroke

Multi-Recorder - Dynamic Measurement Software TMR-7630

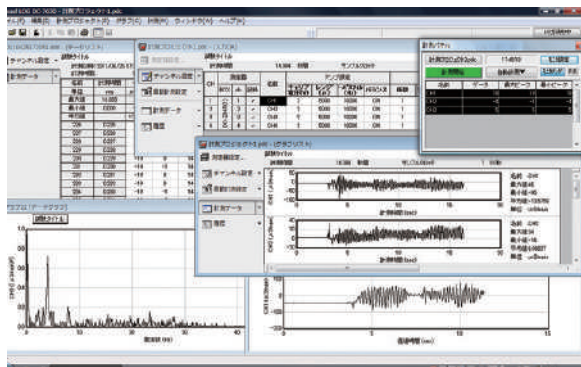

Software for multi-channel dynamic measurement and data processing using TMR-300 series, Simultaneously controls 320 points at the maximum
 Applicable instrument: TMR-311 up to 4 units

Input/output units connectable to TMR-311
 Up to 10 units for each TMR-311 (320 points at maximum)

Operating environment

OS: MS Windows 7(SP1) / 8.1 / 10 / 11
 Computer: Model recommended by the above OS, CD drive
 Memory: Free space of 120MByte or more
 HDD: Free space of 10MByte or more (when setting up)
 Interface: LAN, USB

- Maximum number of calculation data items: 1,000
- Real time graph display while sampling
- Automatic data acquisition by Interval/Data trigger/External trigger/Free run/ Data comparator measurement
- Overlaying of graphs of data from different data files
- TMR-7630-H (option): Frequency analysis of measured dynamic wave form by post-processing
- TMR-7630-M (option): Data reproduction synchronized with saved videos

Smart Dynamic Strain Recorder - Dynamic Measurement Software DC-7630

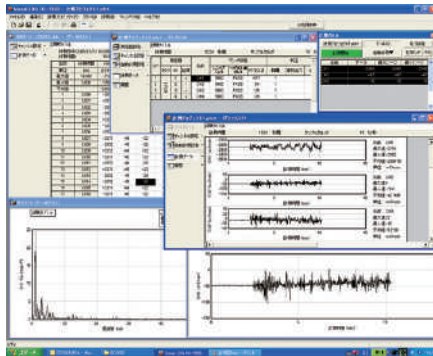

Software for multi-channel dynamic measurement using Smart Dynamic Strain Recorder DC-204R/DC-204Ra

Applicable instrument: DC-204R/DC-204Ra (up to 4 units for 32 points)

Operating environment

OS: MS Windows 7(SP1) / 8.1 / 10 / 11
 Computer: Model recommended by the above OS, CD drive
 Memory: Free space of 120MByte or more
 HDD: Free space of 10MByte or more (when setting up)
 Interface: USB

- Maximum number of calculation data items: 100
- Real time graph display while sampling
- Automatic data acquisition by Interval/Data trigger/External trigger/Free run/ Data comparator measurement
- Overlaying of graphs of data from different data files
- Text conversion of data: CSV format, DADiSP compatible format
- DC-7630-M (option): Data reproduction synchronized with videos

Real time Data Acquisition Software RD-7640

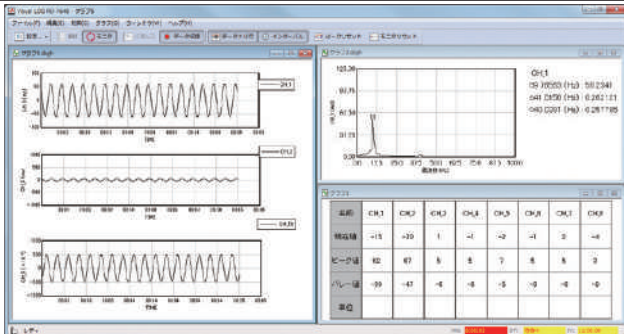

Measurement software for controlling TMR-311 or DS-50A and executing monitoring/manual/data trigger/interval measurement for 1~1000 channels of measuring points and up to 1000 channels of expanded channels, Data recording format is DADiSP compatible

Operating environment

OS: MS Windows 7(SP1) / 8.1 / 10 / 11
 Computer: Model recommended by the above OS with CPU of Intel Core i5 3.0GHz or higher is recommended (excluding Turbo Boost), CD drive
 Memory: Free space of 4GByte or more
 HDD: Free space of 5MByte or more (when setting up)

- Performs FFT analysis for optionally selected channel and displays spectrum
- Number of expanded channel for calculation of channel data is 1000
- Monitoring, manual, data trigger and interval measurement are available for measurement, and all of them can be performed simultaneously

MEASUREMENT SOFTWARE Visual LOG

Waveform View Software WF-7630



Software for viewing DADISP format data as data list and waveform. DADISP format data outputted from DH-14A, TMR-311 or DC-204R/DC-204Ra, or from software DC-7630 or TMR-7630 are acceptable. Possible to execute re-calculation of data, and merging, cutting out, thinning out and CSV conversion of data files. In addition, maximum/minimum search, FFT analysis, calculation using expanded channels, and drawing graphs (X-Y, T-Y, spectrum) are possible.

- Applicable data file: *.hed / *.dat
- Applicable to most of DADISP format instruments and software
- Re-calculation of measured data possible by changing the coefficient, offset, etc.
- Merging of separated files created by free run measurement
- Batch conversion of file name change, cutting out and thinning out is possible in the data file list
- Range selection and thinning out are possible when performing CSV conversion of data file
- Two or more graphs and/or objects are arranged in a graph window
- Graph data are saved as image, or values in graph are saved as CSV file

FFT Analysis and Processing Software DFA-7610

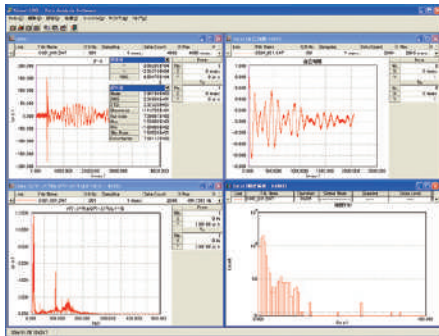

Software for analyzing dynamic data files created by our dynamic strain meter. The analysis includes time-axis waveform processing, X-Y graph, differentiation and integration, and autocorrelation.

Applicable data file: Data files created by software DC-7204 or DC-7630
Operating environment

OS: MS Windows 7(SP1) / 8.1 / 10 / 11

Computer: Model recommended by the above OS, CD drive

Memory: Free space of 32MByte or more

HDD: Free space of 10MByte or more (when setting up)

- Display and processing of time-axis waveform by X-T graph, Display and processing by X-Y graph, Calculation of differentiation and integration, Statistical analysis, Frequency analysis, Transfer function, Histogram analysis, etc.

Monitoring Measurement Software Visual LOG Light TDS-700L

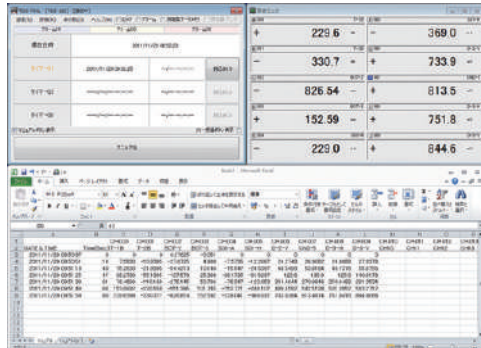

Software for controlling measurement and monitoring with our static data loggers

Applicable instrument: TDS-540, TDS-150, TC-32K, TC-35N

Operating environment

OS: MS Windows 7(SP1) / 8.1 / 10 / 11

Graphic monitor: Using MS-Excel

Data file creation: Using MS-Excel, CSV

- Customized automatic measurement using three timer tables
- Alarm function with three level alarm values
- Velocity alarm suitable to disaster monitoring



JCSS
JCSS 0090

Tokyo Measuring Instruments Laboratory Co., Ltd. (TML) is accredited by Japan Calibration Service System (JCSS), conformed to international standards JIS Q 17025 (ISO/IEC 17025) under the laboratory accreditation body ISO/IEC 17011. International Accreditation Japan (IA Japan) plays as the accreditation body of JCSS and is a signatory to MRA of Asia Pacific Accreditation Cooperation (APAC) as well as International Laboratory Accreditation Cooperation (ILAC). Our Kiryu factory is certified as a JCSS-accredited laboratory working in compliance with an international Mutual Recognition Arrangement (MRA). The accreditation number of the Kiryu Factory is 0090.



Approval Certificate **ISO9001**
Design and manufacture of
strain gauges, strain measuring
equipment and transducers



TML

URL www.tml.jp/e

8-2, Minami-ohi 6-chome, Shinagawa-ku, Tokyo 140-8560, JAPAN
TEL: +81-3-3763-5614 FAX: +81-3-3763-5713

The contents of this catalog are subject to change without prior notice.
The contents of this catalog are as of February 2024. TML Pam E-8501J